

IMCCE/PARIS OBSERVATORY

Astrometry through photometry

Application to natural planetary satellites and
solar system objects

J.E. Arlot

05/04/2013



Lecture provided for amateur and professional astronomers for natural satellite event observations.

Astrometry through photometry

Application to natural satellites and solar system objects

J.E. Arlot
v10, April 2013

Astrometry is usually measuring an angular distance on the celestial sphere. Only radar or laser are able to measure directly distances in kilometers. Astrometry through photometry will measure a light flux received from one or several bodies, related to their relative positions. For example, when we have an eclipse of the Sun, we observe a decrease of the flux of the Sun and we may say that at that time, the relative apparent angular distance Sun-Moon is near zero at the maximum of the eclipse. This is the principle of the astrometry through photometry. However, this method is not applied to the Sun and the Moon. It may be applied for the Moon and the stars (occultations of stars by the Moon) but these observations are no more used for the determination of the position of the Moon as we will see latter. Occultations of stars by asteroids provide the size of the object and its relative position to the star. Other important occultations are the phenomena of the planetary satellites involving two natural satellites of a giant planet.

I- Elements of photometry

1) What is photometry?

We do not intend to provide lessons on photometry: the reader will consult books specialized in this topic. However, we must say that, contrarily to astrometry, the purpose of which being to measure a position or a dimension either in kilometers or, more often, in angle units on the celestial sphere, the photometry intends to measure a quantity of light received from a celestial object. As astrometry needs reference frames, photometry needs standards and references for the calibration of the quantity of light measured.

The wavelengths

It is well known that the light received from the celestial objects has a different intensity depending on the wavelength in which one will measure the light flux (that corresponds to the spectrum of the object). Each star has a specific spectral signature, as the Sun. Of course, all the solar system objects are only reflecting the light of the Sun, so that the spectral profile of these objects is similar to the Sun. This will simplify our measurements even all the objects are not reflecting the light of the Sun with the same manner.

The calibration

When measuring a flux of light, we will need references: we will always measure reference sources at the same time as the measurement of the light from our object of interest. Note that the reference must have the same spectral profile, so that another object of the solar system may be used for that purpose. Anyway, if using stars, one will be careful concerning its spectral profile.

The filters

Since all solar system objects have the same spectral signature, observations may be made recording all light but this will make difficult the reduction of the observations. We have to take into account that solar system objects have different colours due to absorption by the

surfaces. We know the ratio of light reflected by the body in only some specific wavelengths (albedo) that will be useful for the reduction so that the observation should be made only in these wavelengths which correspond to some filters to be used. Most of the filters are standard in order to observe in the same wavelength. R or V filters are the most commonly used for the observation of solar system object. In some cases, we will choose a very specific wavelength in order to eliminate some excess of light. For example, near a giant planet, it is preferable to observe in a wavelength where the planet is dark as we will see later. The next figure shows the profile of the standard filters used at Haute Provence Observatory (OHP).

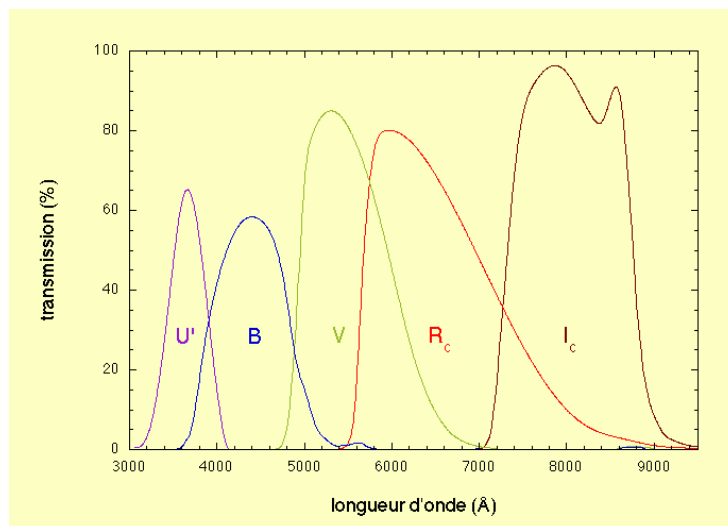

Figure: main filters used on the 120cm telescope at OHP

The receptors and the observation

In the case of observation of phenomena, we need a fast receptor, able to record the light emitted by the objects during a short interval de time, less than one second of time. CCD, video camera or video camera with possible integrated time (Watec,...) are very good for our photometric use. For each recording of light, a complete image of the field is recorded and other objects may be used as photometric reference. Of course, a specific attention must be made to the photometric quality of the receptor. Its linearity is very important: the signal for a given flux must be ten times the signal for a tenth of the flux, ... The next figure shows the sensitivity of the CCD used at the 120 cm telescope of OHP.

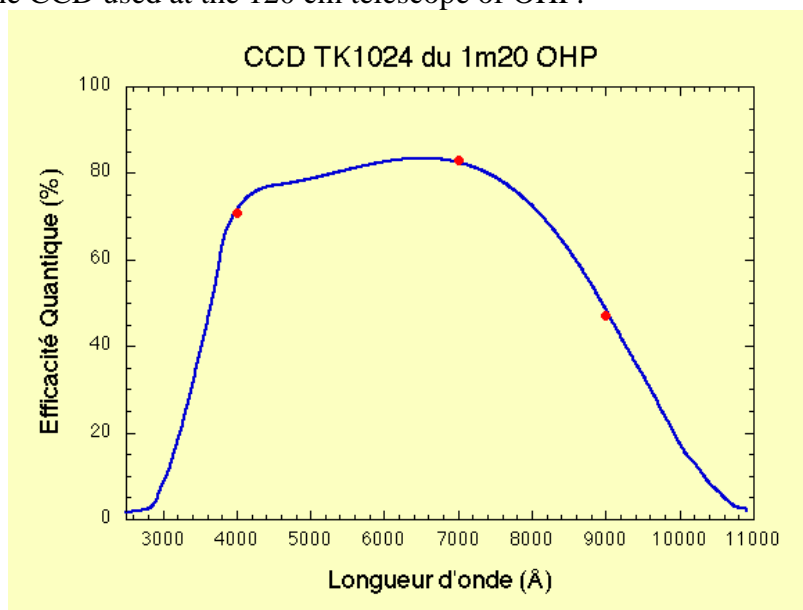
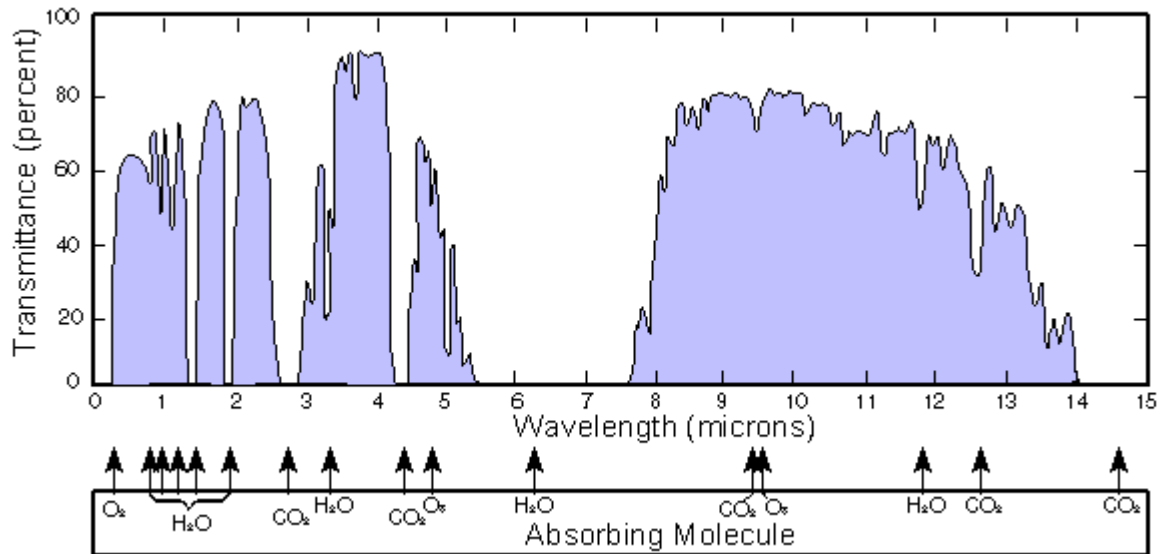

Figure: sensitivity of the CCD of the 120 cm telescope of OHP

So that, the results of the observation is a combination between the filter used and the CCD sensitivity. Of course, it is possible to observe without filters: then, the transmission window will be the profile of sensitivity of the CCD. Such an observation will be difficult to be compared to others or to be reduced: most of the parameters needed for the reduction are provided in a specific wavelength corresponding to a standard filter. With large telescopes, the infra red observations may be very interesting: the bright giant planets become dark in some infra red wavelengths (K-band at $2.2 \mu\text{m}$) making the satellites easily observable. However, the infra red wavelengths have only some narrow windows for crossing the atmosphere of the Earth as shown below.



2) Photometry of solar system object: the reflectance laws

Astrometry usually deals with punctual sources. The image of a star on the focal plane of a telescope is the diffraction image, the photocenter of which is easy to determine since we know exactly the profile of the image. Unfortunately, the solar system objects are not punctual sources and we have model the different types of objects in order to be able to get astrometric data of high accuracy.

The phase effect

The table below shows the apparent size of several objects: it is impossible to consider them as points even if the diffraction image is larger than the size of the object in the focal plane. However, the problem comes mainly because of the non-symmetrical profile of the image of solar system object. The main goal of astrometry of solar system objects is to determine the position of the centre of mass but the astrometric observation provides the photocenter or centre of light. In a first approximation, the center of mass may be consider as the center of the geometric figure of the object, mainly for spherical object. The photocenter is different because of the brightness of the surfaces not always uniform and of the existence of the phase angle. The figure below shows what is the influence of the phase angle on the image of a body as seen from the Earth.

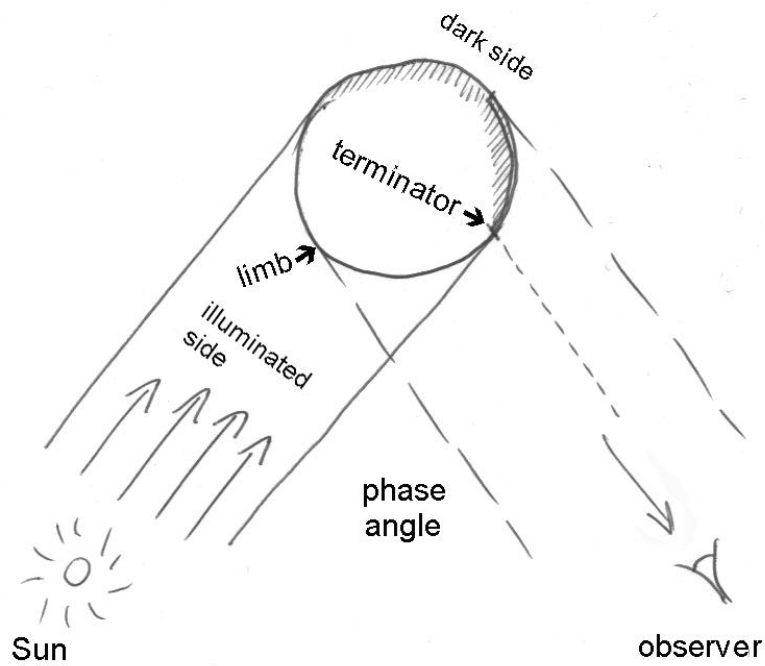

Figure: phase angle, limb, terminator

The size of this effect depends on the body as shown by the following table, calculated using the formula:

$$-\Delta \alpha \cos \delta = C s \sin (i/2) \sin Q$$

$$-\Delta \delta = C s \sin (i/2) \cos Q$$

where

α , δ are the right ascension and the declination

i is the phase angle

C is a coefficient depending on the law of diffusion , 0.75 for Lambert law

s is the apparent radius of the body in radians.

Q is the position angle of the equator of intensity

Table: apparent diameter and phase defects for the main objects of the solar system

	Apparent diameter in arcsec	Diameter in km	Maximum phase angle in degrees	Maximum phase defect in km	Maximum phase defect in arcsec
Mars	26	6794	35	1050	4
Jupiter	50	143 000	12	7474	2.6
Saturn	21	120 536	6	3154	0.5
Uranus	4	51 118	2.5	558	0.044
Neptune	2.4	49 528	1.2	259	0.013
Io J-1	1.1	3630	12	190	0.057

Europa J-2	1	3138	12	164	0.052
Ganymede J-3	1.6	5268	12	275	0.084
Callisto J-4	1.4	4800	12	251	0.073
Rhea S-5	0.4	1528	6	40	0.010
Titan S-6	0.9	5150	6	135	0.024
U-3 Titania	0.11	1578	2.5	17	0.001
N-1 Triton	0.13	2705	1.2	14	0.0007

The planet Venus or the Moon shows all the possible phase angles but are now observed using other astrometric methods than imaging. For all the outer planets, the phase angle has a maximum as shown in the table above.

The main effects due to their size are:

- the limb-centre effect: it is easy to understand that an object has not the same brightness at its center and on the limbs. This comes mainly from the nature of the surface, if there is an atmosphere or not. A planet as Jupiter has a strong limb-centre effect due to its atmosphere: the object seems to be spherical. Contrarily, the Moon has a very small limb-centre effect: it seems to be flat. If this effect remains symmetrical it may not affect the position of the photocenter. However, the phase angle will make not symmetrical the image of such a body.



- the surface effects: this effect comes from the non-uniformity of the disc of the object, some areas being brighter than others. This will affect directly the position of the photocenter. For example, what we name the “seas” on the Moon are areas darker than the rest of the surface. Even if we do not see directly the surfaces, the photocenter of the diffraction figure will be moved. The brightness of a surface depends on the “albedo” that we will define below.

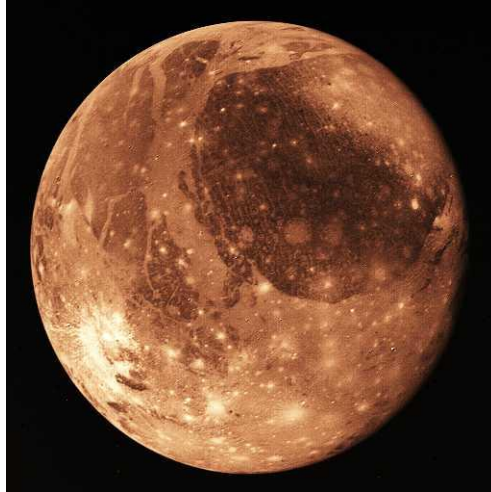

- The tri-axial effect: for an object non spherical the photocenter may change depending on the aspect of the body as seen from the Earth. This is the case for the asteroid as shown by the image below. For high precision astrometry, this has to be taken into account.



The asteroid Ida

Let us remind the problem to be solved. We have no more a point for which we need the position but a surface which has not a uniform brightness. The first problem to be solved is to determine the brightness of each small area of the surface of the object taking into account the nature of the surface, the phase angle. Note that we may consider that the grounds of the objects are all the same anywhere on the object and that the different brightness are due to phase or that the grounds differ from an area to another on the object that makes necessary to have a map of intrinsic brightness of the object. In both case we need to know the laws of reflection on the body.

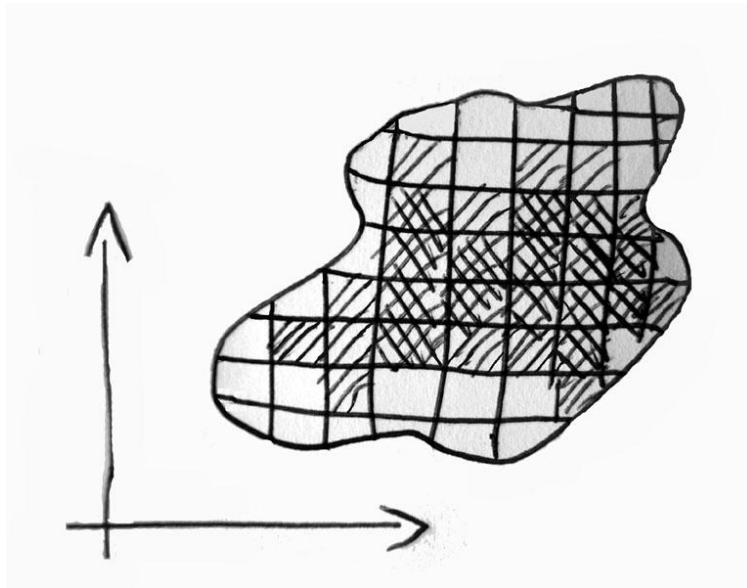

Integrating the observed surface of an object

Having the knowledge of the brightness of each element of surface of an object, we may now solve two different problems.

The photocenter of the disk

We first would like to know the difference between the photocenter or center of light of an object and its center of mass, approximate by the center of the figure for a spherical object. This will allow the astrometric exploitation of direct imaging of the object and measurement of its position. Each small part of the object will have its brightness and by integration on all the surface of the object we will find the photocenter, moved towards bright regions of the body.

The photometric flux

The second task of the photometric analysis of the surfaces will be to deduce positions from a flux measured during an occultation. A part of an object is occulted by another object. Even in relative photometry, we need to know exactly which part of the occulted object will be occulted. If the bodies were uniform, the minimum of flux will correspond directly to the minimum of distance and the correspondence between the magnitude drop and the distance will be proportional to the occulted surface. Since each small area of the occulted body has its own brightness, we need to integrate the flux on all the non occulted part through the photometric function. Then, we will inverse the light curve, deducing several parameters including the distance between the objects, from the fit of the observed light curve on its theoretical model.

Defintion of the albedo:

Geometric albedo: ratio of the mean luminance of the body for a zero phase to the luminance of a perfect scatterer receiving the same light at the same distance of the observer

Spherical albedo or Bond's albedo: ratio of all the light flux reflected by a body to the total flux intercepted by the sphere in a parallel rays light.

The albedo is supposed to be between 0 and 1 (the geometric albedo may exceed 1 for a body such as a mirror; the spherical albedo may exceed A for a body emitting light by himself).
Example of Bond's albedoes: the Moon is very dark and has an albedo from 0.1 to 0.2; a body covered with snow (ice water snow) has an albedo from 0.8 to 0.9.

The laws of reflexion-diffusion of light

In order to find the center of figure from the photocenter, we must have the laws of reflection of the light at the surface of the body.

The figures below show:

- the diagram of bidirectional reflectance from a surface
- the luminance coordinates for a spherical object
- the geometry of scattering from inside the surface medium of the object

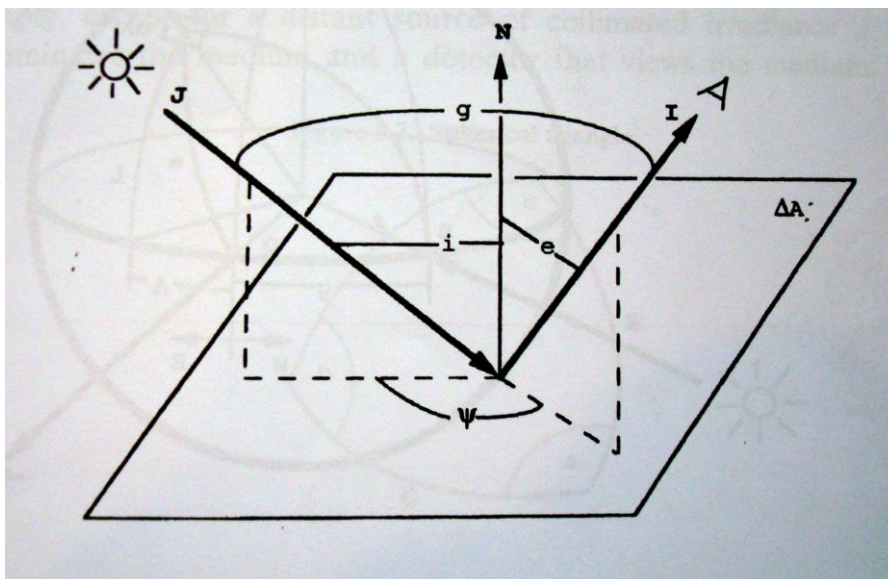

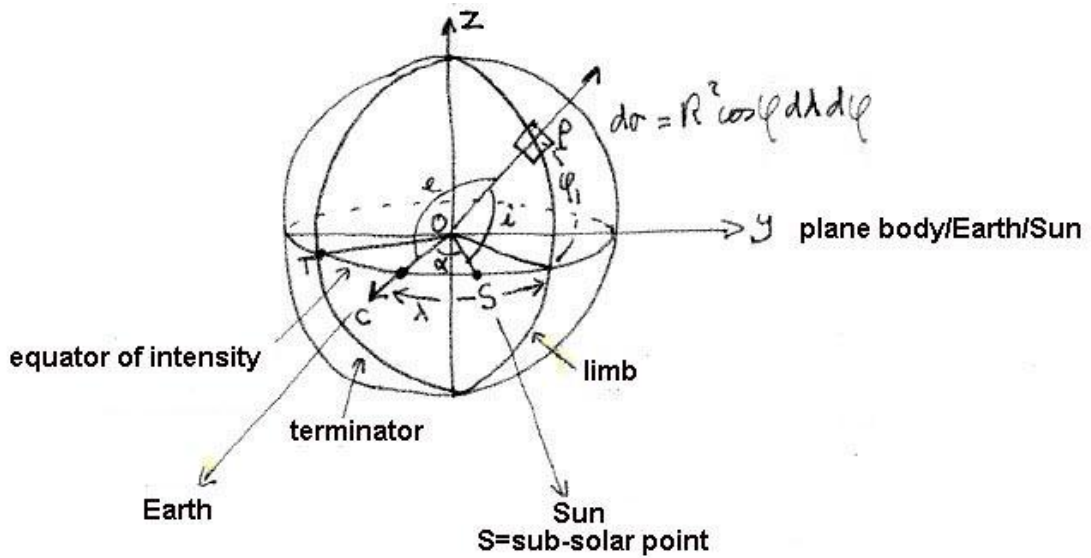

α = phase angle

i = incident angle

e = reflexion angle or angle of observation

λ = photometric longitude

ϕ = photometric latitude

$$\mu_0 = \cos i$$

$$\mu = \cos e$$

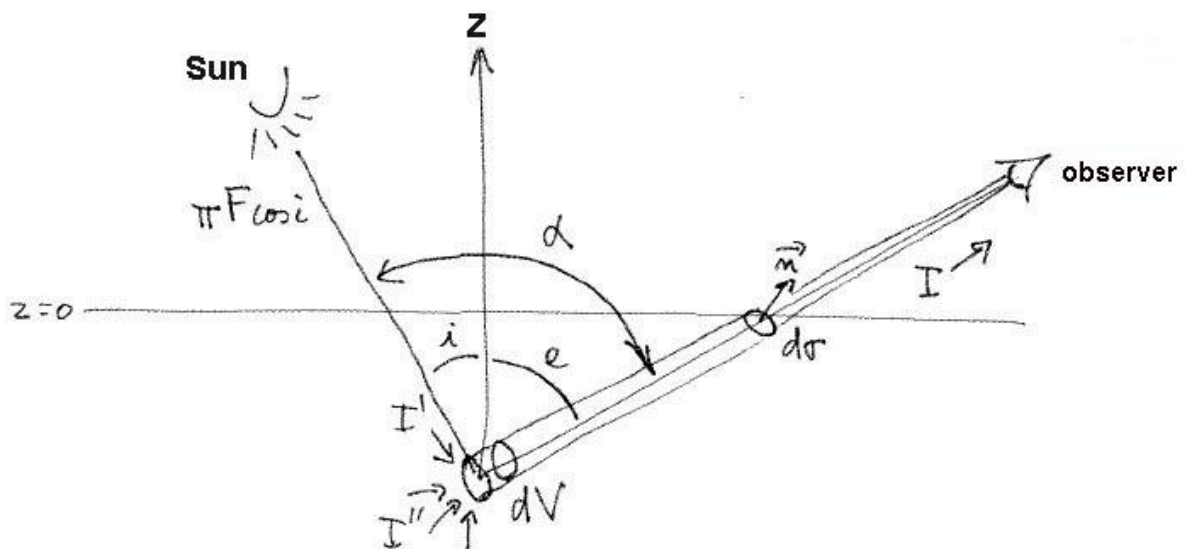

We have:

α = phase angle

i = incident angle

e = reflective or observer angle

λ = photometric longitude

ϕ = photometric latitude

We set:

$$\mu_0 = \cos i$$

$$\mu = \cos e$$

Let us consider a small element dV inside the medium illuminated by the incoming incident light I' arriving unto dV and illuminated by the scattering light from the medium, scattered by the particles around dV .

Let be πF the incoming solar flux and I the intensity of the scattered light received by the observer. I depends on I , e and α

The relationship between I and F is called "scattering law" of the medium.

We have:

$$I(i, e, \alpha) = F/4\mu \times S(i, e, \alpha, p_j)$$

Where S is called the function of scattering of the medium

p_j are the parameters describing the physical characteristics of the medium: albedo, porosity, rugosity.

The factor $1/\mu$ is introduced in order to subscribe to the principle of reciprocity that means that when the light is absorbed, diffracted, reflected and refracted, the scattered function is symmetrical referred to incident and reflected rays, i.e. this function is not changed if the directions of incidence and emergence are not changed.

$$I(i, e, \alpha, p_j)/\mu_0 = I(e, I, \alpha, p_j)/\mu$$

$$S(i, e, \alpha, p_j) = S(e, I, \alpha, p_j)$$

The total intensity or luminance or brightness coming from a body and received on a surface unit of the detector situated at a distance D from the body S for a monochromatic wavelength ν

$$I_T = \frac{1}{\Delta^2} \int_S I_\nu(i, e, \alpha) \cos e \, d\sigma$$

It is this quantity which is measured on Earth during photometric observations

Of course I depends on λ and ϕ and may be written:

$$F \times \cos e \times \cos i \times f(\nu) \quad \text{for Lambert law}$$

and:

$$d\sigma = R^2 \cos \gamma \, d\lambda \, d\varphi$$

So, the luminance = the flux of light x law of diffusion

The scattered laws to be used

The Lambert law

This law is the more simple: it assumes that the intensity I depends only on the incident angle i (not on e). So, the intensity of an element of surface depends only on the area projected normal to the direction of the observer:

$$\frac{I}{F}(i, e, \alpha) = \mu_0$$

This law is used for bright objects mainly those with an atmosphere

The Lommel-Seeliger law

This law considers that the light enters the body and is absorbed exponentially, and that each element of volume becomes a source emitting outside, being also absorbed exponentially. The scattering is isotropic and we have:

$$\frac{I}{F}(i, e, \alpha) = \frac{\mu_0}{\mu_0 + \mu}$$

This law is used for dark bodies without atmosphere

The Minnaert law

This law is totally empirical and we introduce parameters B_0 and k depending on the phase and on the wavelength. k is the parameter of darkening of the limb

If $k = 0.5$, no darkening (for example, the Moon, flat aspect)

If $k = 1$: strong darkening (for example, giant planets, apparent rotundity)

$$\frac{I}{F}(i, e, \alpha) = B_0 \mu_0^k \mu^{k-1}$$

This law is used for small phase angle

The Hapke law

This law is much more elaborated and intends to describe the surface of the bodies. We will distinguish two different cases.

Case of smooth surfaces

Let us first see the case of surfaces very flat with very small particles, even much more larger than the wavelength of the light. The law becomes:

$$\frac{I}{F}(i, e, \alpha) = \frac{\tilde{\omega}_0}{4} \frac{\mu_0}{\mu_0 + \mu} \left\{ [1 + B(\alpha, h)] P(\alpha) + H(\mu_0) H(\mu) - 1 \right\}$$

where:

$\tilde{\omega}_0$ is the albedo of single diffusion which depends on the particles at the surface.

$B(\alpha, h)$ is the opposition function describing the phase effect on each surface particle

$P(\alpha)$ is the phase function of diffusion: it is the fraction of incident light included inside the solid-angle unit around the direction of incidence, reflected inside the solid-angle unit around the direction of the observer

H is the function of multiple diffusion not depending on the phase

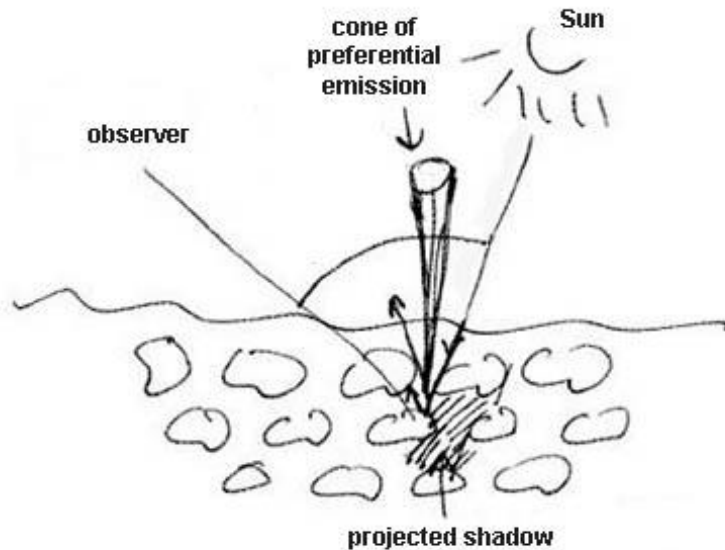

Case of rugosity surfaces

The observation is not totally in agreement with the law above because, we do not take into account the macroscopic rugosities which will darken the surface near the limb due to shadows. Each part of the surface is no more horizontal and the angles i and e become i' and e' (i.e. μ and μ_0 become μ' and μ_0'). The law becomes:

$$\frac{I}{F}(i, e, \alpha) = \frac{\omega_0}{4} \frac{\mu_0'}{\mu_0' + \mu'} \left\{ - \right\} \times T(i, e, \psi)$$

where T is the shadow function.

This law is a good model but it does not take into account the illumination of the areas in shadow by the bright areas.

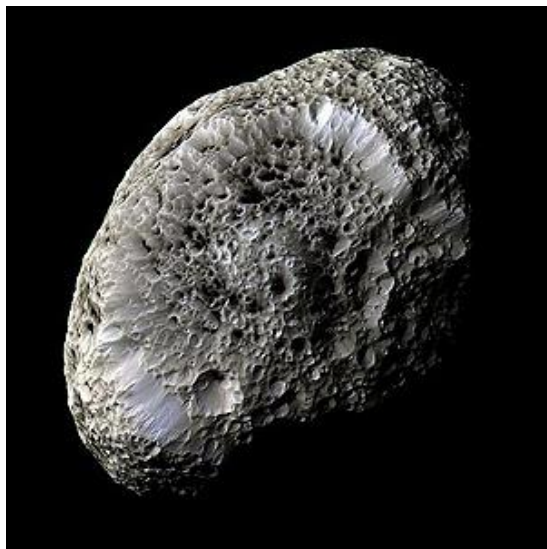

An example of a surface difficult to model (Hyperion). In fact, the scattering laws do not model the macroscopic deformations of the surfaces.

II- The occultation of stars

Occultations of stars are similar to the eclipses of the Sun by the Moon. Similarly, the totality of the phenomenon (total occultation of the star or of the Sun), may be observed only on a small geographic zone on Earth. For the solar eclipses, the determination of this zone is more difficult because, objects are moving fast, relative distances are changing fast too. For the occultation of stars, the star is considered to be at the infinite, so that the shadow cone (which defines the totality zone on Earth) may be considered as a cylinder defined by the occulting object. From these considerations, one may see that the information to be deduced from the observations are different depending on the occulting object. In any case, the astrometric information will be the position of the occulting object deduced from the position of the star itself. The astrometric accuracy will depend on the size of the object which defines the zone on Earth where the total occultation is observable.

1) The occultations by the Moon

The first observations of occultations which were performed were the occultations of stars by the Moon. The size of the Moon and the numerous bright stars occulted by the Moon during its motion on the celestial sphere made these observations very easy. Of course, the first goal was to measure the astrometric position of the Moon for dynamical purpose. The arrival of the laser ranging thanks to the target put on the Moon allows to measure the distance Earth-Moon with a very high accuracy making the observation of occultations no more useful. However, let's understand the mechanism of the occultations by the Moon: the interest of such observations will appear.

When the disc of the Moon occults a star, the light received from the star will not be at level 1 and suddenly going at level zero during a time interval corresponding exactly to the disappearance of the star behind the Moon (depending only on the size of the star). We have to take into account the diffraction of light which will make a light curve perturbed by diffraction fringes as shown on the next figure.

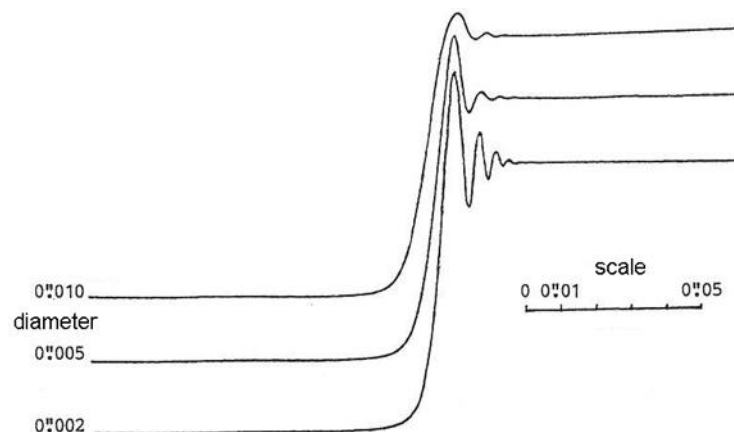

Figure: the light curve observed during an occultation of a star by the Moon depending on the diameter of the star.

The observation may be made in several wavelengths and the sampling of the light curve must be very high in order to get as many points as necessary during the diffraction of the light. Then, since the velocity of the Moon is well known, the information deduced from the light curve will be the diameter of the star which is not reachable easily with any other observation. The equation of the flux is:

$$Flux = F \left(\frac{1}{\Delta_*}, \frac{1}{D_{occ}}, v_{occ}, \frac{1}{\lambda}, D_T, t_{occ} \right)$$

where Δ_* is the diameter of the star, D_{occ} , the distance to the occulting body, v_{occ} the velocity of the occulting body relative to the star, λ the wavelength, D_T , the diameter of the telescope and t_{occ} , the time of the occultation.

2) The occultations by the asteroids and by the satellites

As we saw it previously, the effect of the diffraction decreases when the occulting object is far from the Earth (the observer). Then, during the occultation of a star by an asteroid, the diffraction effect is negligible and it is easy to measure the duration of the extinction of the star. The velocity of the asteroid being well known, the size of the asteroid is deduced from the duration of the extinction. The next figure shows a light curve recorded during an occultation of a star by an asteroid. However, only one light curve provides only one dimension of the asteroid. Since the star is quite at the infinite, the area on Earth where the extinction is observable is the projection on Earth of the asteroid (the intersection of a cylinder built by the asteroid with the surface of the Earth). The motion of the asteroid and the Earth, made the zone of visibility as a band similar to those corresponding to the visibility of a total solar eclipse. Then, predictions using the ephemerides of the asteroid and the position of the star are provided as maps showing the area of visibility.

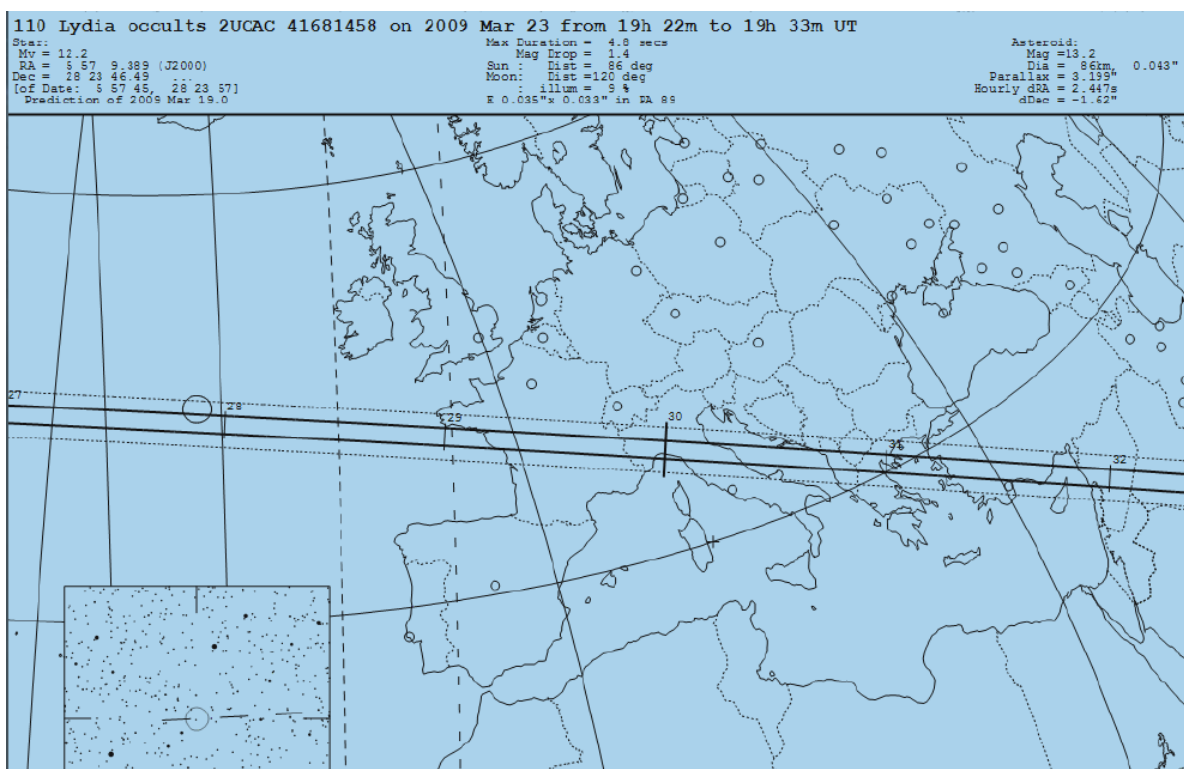

Figure: the area of visibility of the occultation of an UCAC2 star by Lydia

Unfortunately, the area is the projection of the asteroid size and is, most of time, less than 100 km wide, since the astrometric accuracy of the prediction (accuracy of the ephemerides and of the star catalogue) is most of time around 1000 or 2000 km ! Observers will have to be numerous and to observe not only on the predicted path of the “shadow” of the asteroid but

also 1000 km around the predicted path. When the occultation is observed, the astrometry of the asteroid relative to the star becomes a few kilometers and the profile of the asteroid is determined thanks to a good timing of the observations. All the observations must be dated in Universal Time within more than 0.1 second of time. The next figure shows a network of observers for the observation of a predicted occultation and the figure after shows a profile of an asteroid after observations made through such a network. Note that the repartition of light on the surface of the occulting object is not to be taken into account: only the total light may be useful but most of time, the occulted star is much more bright than the occulting object.

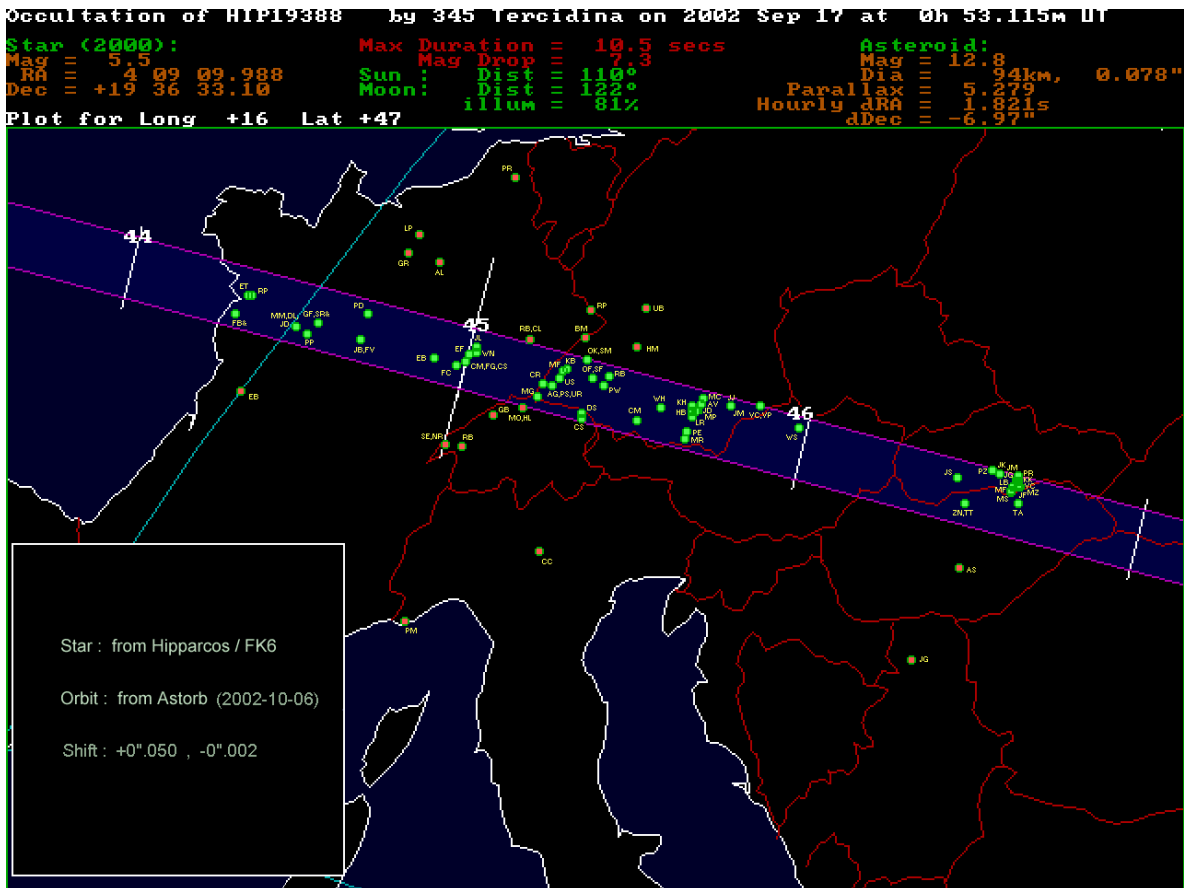

Figure: the network of observers for the occultation by Tercidina

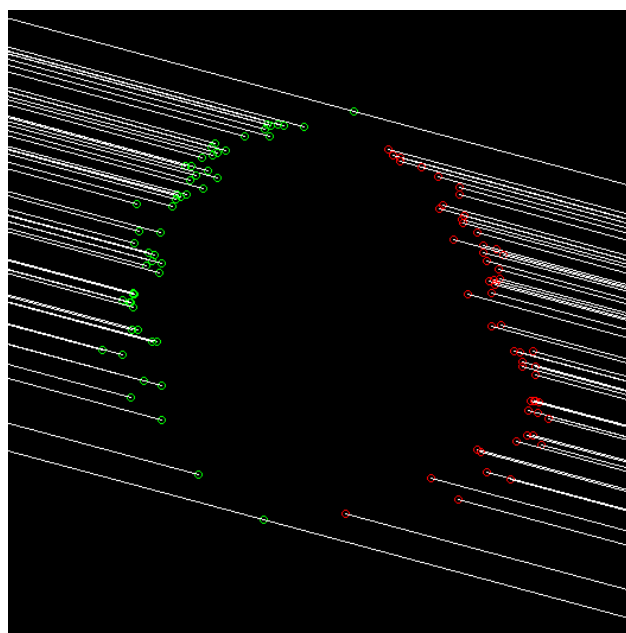
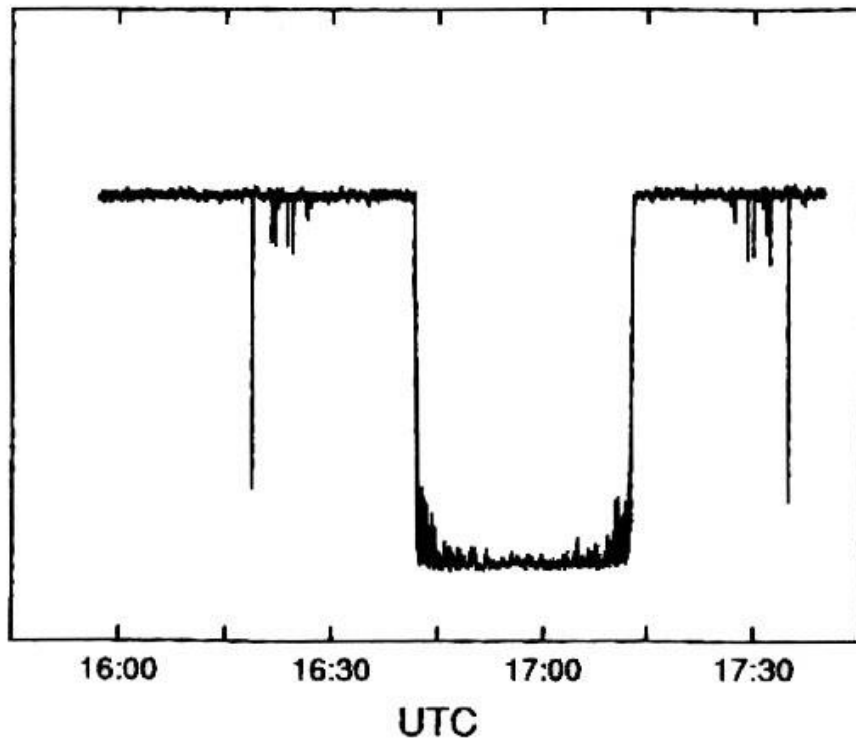

Figure: the profile of the asteroid Tercidina from the observations

3) The occultations by the planets

Planets occult also stars but the goal is different when the planet has an atmosphere: the light of the star is refracted by the atmosphere of the planet and features appear on the light curve. The interpretation of these features provide information on the nature and temperature of the atmosphere. Astrometry is not a goal for these observations.



On the above light curve, it is easy to see:

- the interruption of the light flux during the occultation of the star by Uranus
- the variation of the flux of the star when the light is crossing the atmosphere of Uranus
- the light interruption of the flux of the star when the light is crossing the rings

III-The mutual occultations and eclipses

1) The systems of the giant planets

All the giant planets Jupiter, Saturn, Uranus and Neptune present systems of satellites which look like small solar systems and where all the gravitational and physical problems are gathered. Since the satellites are moving around their planet faster than the planets around the Sun, these systems are laboratories for the study of the formation and the evolution of the solar system.

These systems present similar distribution of bodies:

- rings and small satellites shepherding the rings
- small inner satellites orbiting close to the rings
- main satellites looking like small planets (note that Ganymede, the third satellite of Jupiter has the size of the planet Mars and is larger than the planet Mercury).
- irregular outer faint satellites orbiting far from the planet. They look like asteroids and are orbiting around their planet gathered by families.

The table below provides statistics concerning these satellites.

	Inner satellites	Main satellites	Outer satellites
Jupiter	4	4	57
Saturn	15	8	39
Uranus	13	5	9
Neptune	6	2	5

2) The eclipses of the Galilean satellites by Jupiter

As seen by Galileo a few time after their discovery in 1610, the main satellites of Jupiter (as the main satellites of the other giant planets) present phenomena: they go behind or in front of the disc of the planet and they may be eclipsed in the shadow of the planet as shown by the figure below.

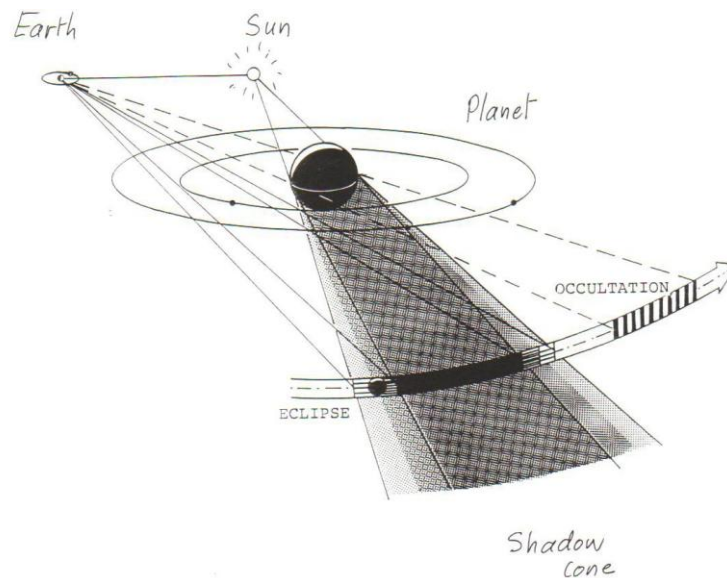

Figure : the phenomena satellites-planet

These phenomena occur only when the Sun is in the orbital plane of the satellite for the eclipses and when the Earth is in this plane for the occultations and during a period when the Sun and the Earth are close to this plane because the planet is not a point and the shadow or the disc is sufficiently large to allow the phenomena to occur not only one time. When have we such a configuration? Note first that the common orbital plane of the main satellites of the giant planets is the equatorial plane of the planet. So, the Sun is in this plane when its planetocentric declination becomes zero, i.e. when it is the “equinox” on the planet. The periodicity of the equinox is the half-duration of one orbital revolution around the Sun, as it is on Earth. The Earth arrives in this plane together with the Sun (a few time before or after), since, as seen from these planets, the Earth follows the Sun in the sky.

What is the interest to observe these phenomena?

The main satellites of Jupiter were observed by Galileo in 1610 and their regular motions appear to be useful as an universal clock. No clock was available with such a permanent regular motion. For this purpose, the need of a theoretical model appears. In order to observe the positions of the satellites at given dates, the observation of the eclipses and the occultations by Jupiter provided positions. When a satellite enters the shadow of the planet,

this means that the satellite is at a very specific position in space. The following figure shows the geometric configuration of such events.

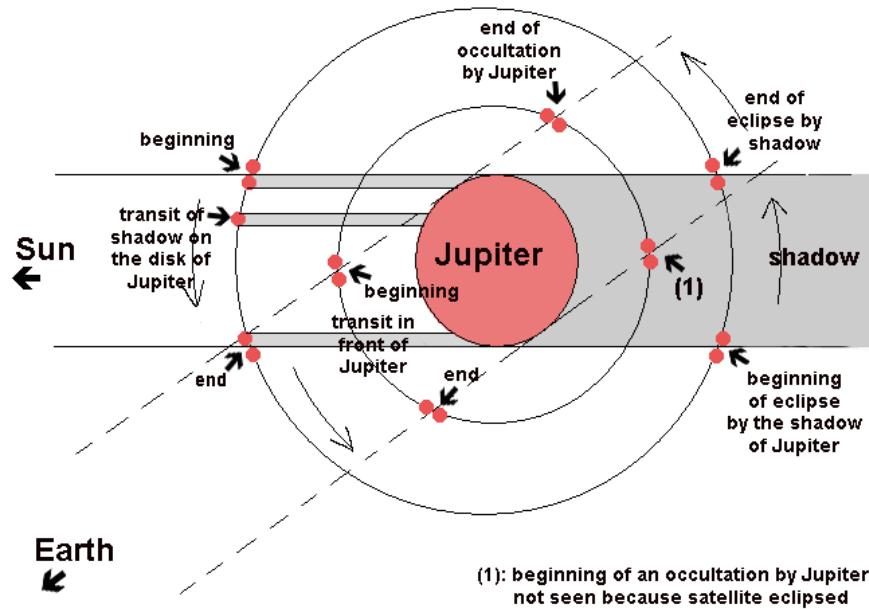

Phenomena of the satellites of Jupiter

Then, it is easy to measure the orbital periods of the satellites and their positions in their orbits. In fact, the ephemerides built using this method in the first half of the XVIIth century (the best by Cassini, director of Paris observatory in 1668) appeared to be irregular. Sometimes the satellites seemed to be late and sometimes to be in advance on the ephemerides. This defect was understood by Roemer in 1681: it was due to the fact that the light has a finite velocity. As shown by the following figure by Roemer, the distance between the system of Jupiter and the Earth varies with the motion of the Earth around the Sun.

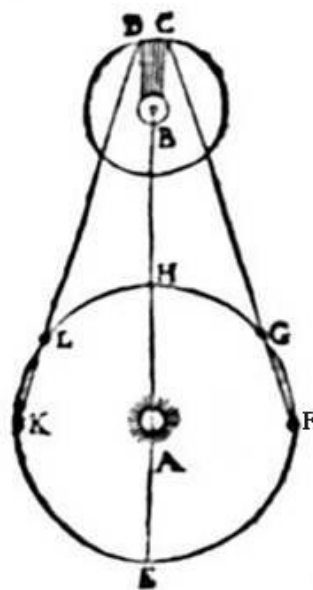

Figure: the changing distance Earth-Jupiter; the events do not occur regularly, showing the velocity of light

The study of the motions of the Galilean satellites began by the time of the first observations. By March 1610, Galileo established that their motions are circular around Jupiter. The first tables of their motions (periods have to be known and an origin for the longitudes must be chosen) were built by Galileo in 1612 and by S. Mayer in 1614. In his tables published in 1656, Hodierna knew the latitudes of the satellites and made predictions of the eclipses. In 1668, J.D. Cassini published his "tables of the motion and of the calculation of the eclipses". Built on a large number of eclipses, these tables were better than the previous ones. They were improved in 1693 (note that in 1675, Roëmer put into evidence the velocity of light thanks to his observations of eclipses of J1, Io).

In 1719, Pound published similar tables to the ones of Cassini for the calculation of the eclipses, but shortened. In 1749 were published the tables (existing from 1718) of Bradley, made from his own observations. Bradley noticed the inequality of 437 days in the dates of the eclipses of the first three satellites. At the same time, Maraldi pointed out the interactions of the satellites, and eccentricities, as well as the nature of the inequalities, were suspected. In 1741, Wargentin published tables that will be improved from 1746 to 1757 thanks to observations of eclipses. At that time, each satellite had an empirical equation and Lalande noted in the "Connaissance des Temps pour 1763" that "the inclinations and the nodes of the orbits have variations which are not well known".

Then, these empirical tables were replaced by tables deduced from mathematical dynamical theories of the motions of the satellites. The first theories are due to Bailly, Lagrange (1766) and mostly to Laplace (1788) who built a complete theory of the motion of the Galilean satellites. Delambre (1791) built tables from Laplace's theory and from 6000 observations of eclipses. Damoiseau did the same and published his tables in 1836. Souillart improved Laplace's theory in 1880 and his work was used to build the tables published in the "Connaissance des Temps". In 1891, other tables were published by Marth. In 1910, Sampson published his tables founded on his new theory which will be published only in 1921. This theory was revitalized in 1977 by Lieske and fitted by Arlot in 1982 on 8856 photographic observations much more accurate than the old observations of eclipses. At last in 2004, Lainey built a brand new theory including all known perturbations of the motions of the satellites, based upon a numerical integration. These last works are the basis of the ephemerides published nowadays in the "Connaissance des Temps" and are used in order to calculate phenomena by Jupiter as well as mutual phenomena.

Why such a large number of works and studies concerning the problem of the ephemerides of the Galilean satellites ? Since the first observations of the jovian system, the importance of the knowledge of the motion of the satellites appeared: the jovian system looked like a clock more perfect than the ones existing at that time and the eclipses were easy to observe. Lalande, in his "Astronomy" (1792) wrote: "they (the Galilean satellites) are continuously used by the astronomers for the determination of the differences in longitude between the different countries of the Earth (...); therefore it was important to have a sure theory of their motions". Cassini, in 1688, published a method to determine the geographic longitudes by the observation of the satellites of Jupiter. Thus, the publication of predictions of the eclipses was of the first importance.

The need for more accurate astrometric data

Nowadays, the study of the motion of the Galilean satellites was made necessary by the need of accurate positions for the preparation of the missions of the space probes Pioneer, Voyager or Galileo to Jupiter and for the exploitation of the data that they provide us. But the nature of the jovian system (fast motions and numerous perturbing forces) makes it a particularly interesting field for the search of small gravitational or non-gravitational effects, not yet put

into evidence, and for the study of the problems related to the resonances and to the tides raised by the planet on the satellites and vice versa.

Such complicated motion was very hard to model and accurate astrometric observations were necessary. Photographic observations appeared at the end of the XIXth century and provide a better accuracy than the observation of the eclipses because of the atmosphere of Jupiter making the cones of shadows not sharp. At the end of the XXth century appeared the electronic receptors as CCD providing a numerical image easier to analyse with computers. But what is the need in astrometric accuracy? When increasing the accuracy of the astrometric observations, it is necessary to take into account more small effects which were neglected before. For example, the effect of the differential refraction is very small for the satellites' systems because of the small size of these systems. So, this effect was neglected until the accuracy increased and now we have to take it into account. Another effect to be taken into account is the difference between the photocenter (what we observe) and the center of mass of the object (of which we model the motion). This implies to know more about the physical nature of the satellites and their surface: the phase angle, taken into account only for the planets, is now taken into account for the satellites themselves. Increasing the astrometric accuracy of the observations will allow quantifying and modelizing some small effects suspected but not measured. For example, the tidal effects between a satellite and its planet lead to an acceleration of the satellite depending on the dissipation of energy inside the planet and inside the satellite (for the Moon, this acceleration makes the Moon escaping the Earth of 3 cm per year (increase of the semi-major axis). The measurement of such a modification of the orbit is possible only with observations accurate to a few kilometers.

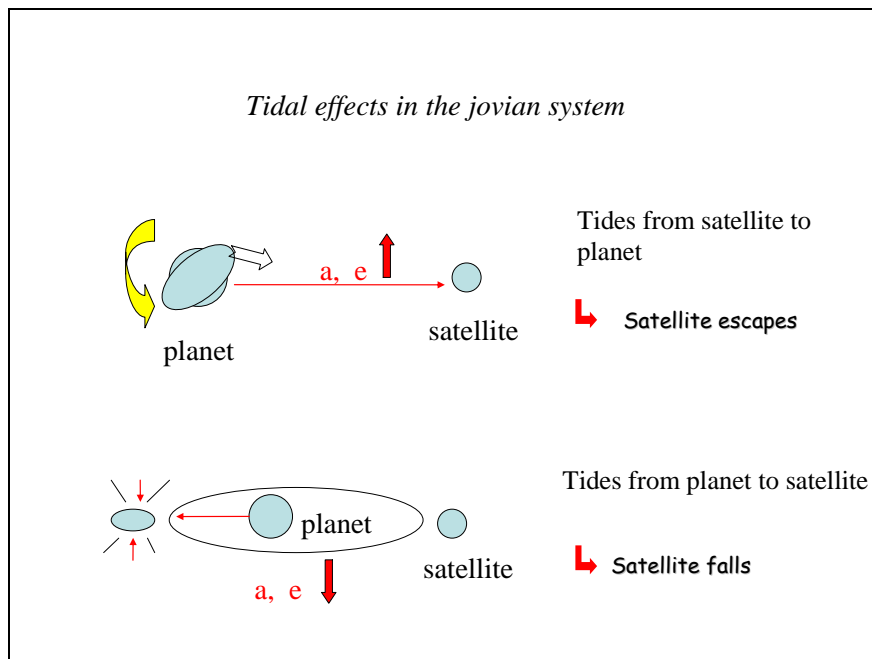

Figure the evolution of the orbits of the satellites through tidal effects

In order to appreciate the possibilities of the different astrometric techniques of observations, we provide below the precisions of the different kinds of observations.

Table: the accuracy of the astrometric techniques

Technique	Accuracy	Objects	
Transit circle	50 → 100 mas	mag 6-15	except Mercury, Venus and Mars
Scanning telescope	50 → 100 mas	→ mag 20	except the planets
Tangential focal plane images	20 → 2000 mas	all	except the planets
Planets through satellites	20 → 50 mas	Mars, Giant planets	only Jupiter & Saturn
AO, IR	a few mas (relative)	inner objects	objects close to their primary
Photometric events	1 → 10 km (relative)	main planetary satellites, asteroids	occultations
VLBI space probes	2 → 10 mas	objects visited by space probes	all
Radar	10 → 100 m	Near Earth Objects	possibly the Galilean satellites
LLR	1 → 3 cm	The Moon	

The observations of the eclipses by Jupiter

So, we see that there are two different way to make astrometry of the planetary satellites: either make precise measurement of positions in the focal plane of a telescope through an image (visual, photographic or CCD), or make a photometric measurement of a light signal increasing or decreasing when a satellite enters a shadow cone. Only the eclipses by the planet are worth to be observed: an occultation by the planet does not provide any astrometric measurement because we do not see the precise position of the limb of the planet. For the eclipse, we do not need to see any imlage, we only record the decrease (when the satellite enters the shadow cone) or the increase (when the satellite exits the shadow cone) of the light received by an Earth-based observer from the satellite. The figure below shows the variation of the light received from a satellite entering the shadow.

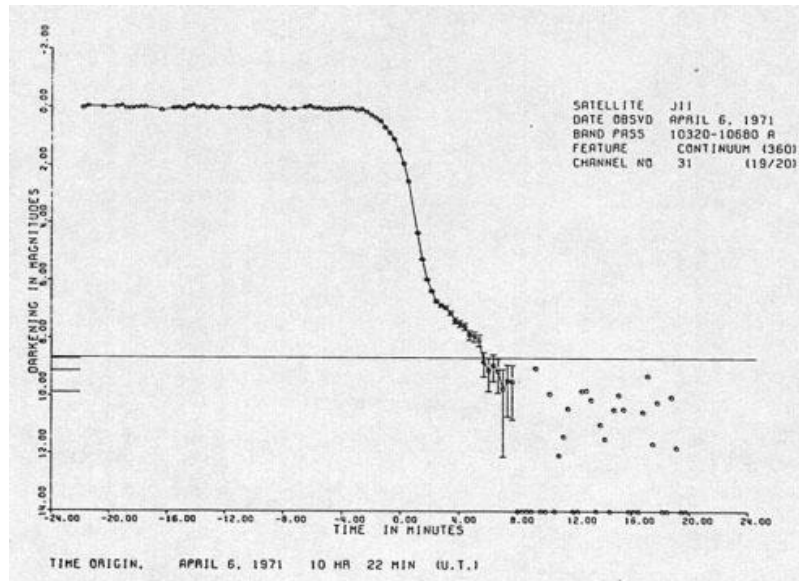
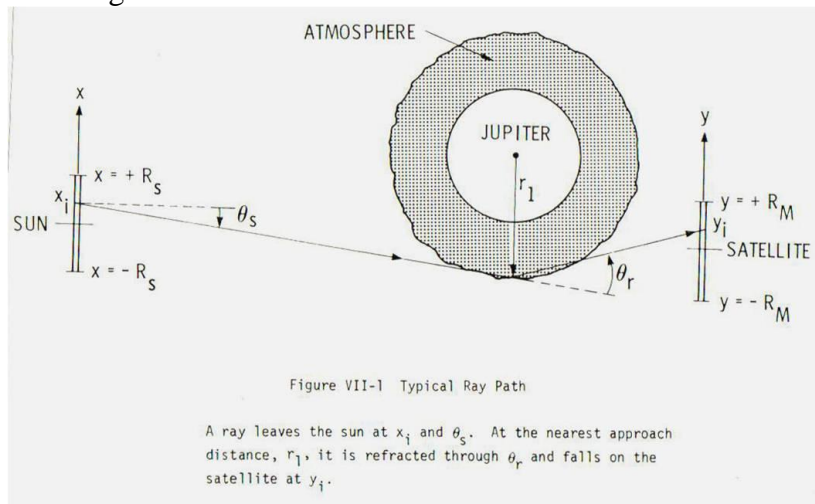

Figure the light curve for an eclipse of J-2 Europa by Jupiter

We need to deal with several difficulties: the poor sharpness of the shadow due to the atmosphere of the planet and the penumbra because of the size of the Sun. The observers use to measure the half magnitude drop which corresponds to a specific position of the satellite. The problem is to be sure of the zero point of the flux, polluted by the light from the planet. In fact, we do not know how the refraction is working in the upper level of Jupiter(s atmosphere as shown on the next figure.



3) Eclipses by Saturn, Uranus and Neptune

The eclipses of the satellites of Jupiter have been extensively observed during centuries. We saw that they are supposed to occur only around the equinox on Jupiter in order to be in a specific configuration. However, Jupiter is so big that eclipses occur every year: the Sun and the Earth are never too high above the equatorial plane of Jupiter except for Callisto which is too far from Jupiter: its eclipses no more occur when we are too far from the equinox. Due to this large number of observable events, observations are still performed nowadays. But what about the eclipses of the satellites of Saturn, Uranus and Neptune? For these systems, the eclipses occur usually too close to the planet to be easily observable. Only a few eclipses are observable only during the quadrature when the shadow cone is not in the alignment Earth-

planet. However, specific “mutual” events of the satellites of Jupiter, Saturn and Uranus may be observed.

4) The magnitudes of the satellites

The observations of the satellites depend on their magnitudes: faint objects will need larger telescopes. We provide below the magnitudes of the satellites and their largest elongation to the planet which is a criterion for an easy observation.

Jupiter	Magnitudes at opposition	Maximum elongation
J-1 Io	5.0	2' 27"
J-2 Europa	5.3	3' 54"
J-3 Ganymede	4.6	6' 13"
J-4 Callisto	5.6	10' 56"

Saturn	Magnitudes at opposition	Maximum elongation
S-1 Mimas	12.9	32"
S-2 Enceladus	11.7	41"
S-3 Tethys	10.3	51"
S-4 Dione	10.4	65"
S-5 Rhea	9.7	90"
S-6 Titan	8.3	209"
S-7 Hyperion	14.2	254"

Uranus	Magnitudes at opposition	Maximum elongation
U-1 Ariel	14.4	15"
U-2 Umbriel	15.3	21"
U-3 Titania	13.9	35"
U-4 Oberon	14.2	47"
U-5 Miranda	16.5	10"

5) The mutual events

After the eclipses by Jupiter, another type of event was observed: the eclipses and occultations between the satellites themselves: the advantage is that the satellites have no atmosphere so that the shadow cones are very sharp and easy to model. During a mutual eclipse or occultation, the light received from the satellites decreases and increases for a few minutes. Contrarily to the eclipses by Jupiter, these events are very rare: they also occur near the equinox for the same reason than for the eclipses by the planet but the small size of the satellites makes the events to occur only during six months before and after the equinox. The figure below shows when the mutual events occur.

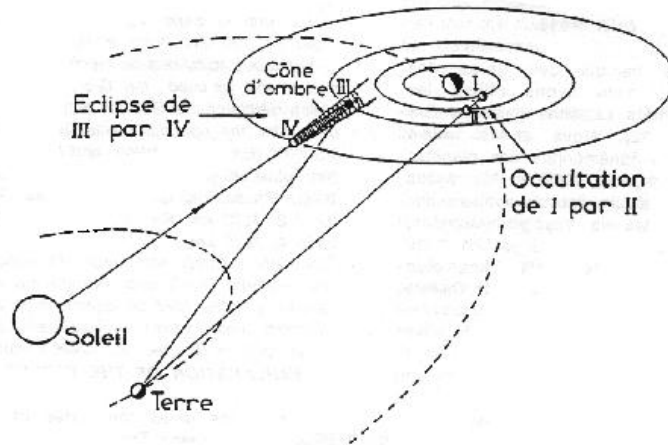

Figure the occurrence of mutual occultations and eclipses

The geometric configuration of the satellites during a mutual event allows getting their relative positions with an accuracy of a few kilometers. The eclipses by Jupiter provides the position of a satellite referred to the planet Jupiter and the mutual events position of a satellite referred to another satellite: this is not a problem since we know that the satellites are orbiting around the planet.

The geometry of the observed mutual events

During an occultation, the disc of a satellite passes in front or behind the disc of another satellite. The light flux received from both satellite decreases compared to the flux of the satellites taken separately, have a minimum and come back to the value of the flux of the two satellites taken separately. A phenomenon occurs when the apparent distance between two satellites is smaller than the sum of the apparent radii (as seen from the Earth for the occultations and from the Sun for the eclipses). The phenomena may be partial, total or annular (as for the Moon). In the case of the eclipses, the eclipse may occur in the penumbra only, but this type of event may be more difficult to observe. We show on the figures below the aspects of the satellites during the events. For the occultations, we do not see such images from Earth since the telescope provides us only the diffraction figure. However, we are interested by the flux emitted by the satellites, not by their image. If the motion of the satellites was circular and without perturbations, the calculations for the predictions would be very simple: for each geocentric or heliocentric conjunction, a phenomenon would occur. It is not the case, and all the perturbing terms in the theory are to be taken into account. Thanks to electronic calculators, the calculations for the predictions may be completed without large errors. However, differences may appear between predictions and observations: the study of these differences may help for the improvement of the theory of the motions. Note that an eclipse is not an occultation seen from the Sun: it is an occultation of the Sun by the eclipsing satellite, as seen from the eclipsed satellite. The velocity of light may be carefully taken into account for the predictions and for the reduction.

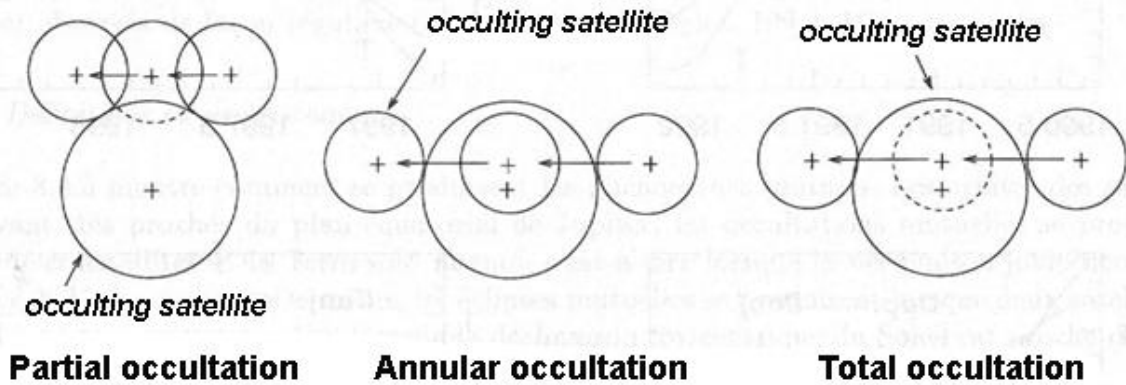

Figure: geometry of a mutual occultation

During an eclipse, a satellite enters the shadow of another satellite: the light flux will decrease, have a minimum and increase after the eclipse. The penumbra will make the light curve slightly different from the occultations. Note that for an occultation, the flux drop will depend on the relative brightness of the satellite. We have to know if the albedoes of the satellites are the same or not. This is not the case for an eclipse, independent of the albedoes.

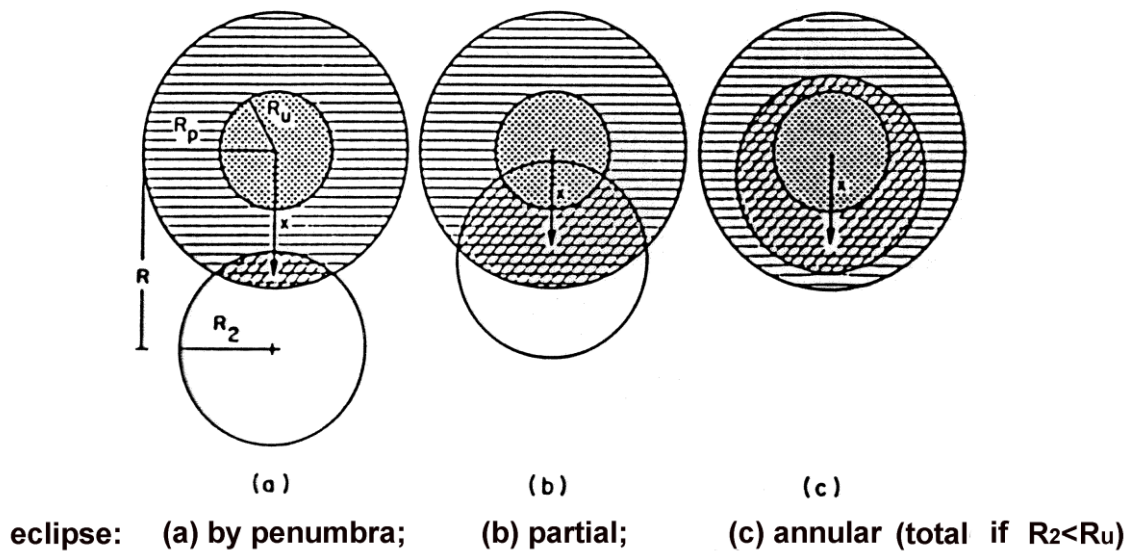

Figure: geometry of a mutual eclipse

What durations and magnitude drops during the mutual events?

The duration of the mutual events are most of time from 2 to 20 minutes of time. The grazing events may be very short with a small magnitude drop and difficult to catch. When one of the satellites is at its orbital elongation, a mutual event may be one hour or more long since the apparent velocities of the satellites are very small. The magnitude drop is small for grazing events and very large (100% decrease of the flux) for total eclipses. Note that during a total occultation, the occulting satellite is always visible and we have never a 100% flux drop. We will see below how is the light curve depending on the nature of the event.

When the mutual events occur ?

We saw that the events occur near the equinox on Jupiter during a few months due to the small size of the satellites and due to the small inclinations of their orbits on the equator of Jupiter. The figures below show the joventric declinations of the Earth and the Sun providing the periods of occurrence of mutual events. The next one will occur in 2009 for Jupiter and Saturn. Note that the observability of the mutual events depends on other criteria: the occurrence of the opposition of the planet and the Sun which determines the period of observability of the planet and the declination of the planet which determines the zones of visibility on Earth (northern or southern hemisphere)

Figure the planetocentric declinations of the Sun and the Earth in 2009
Case of Jupiter-2009

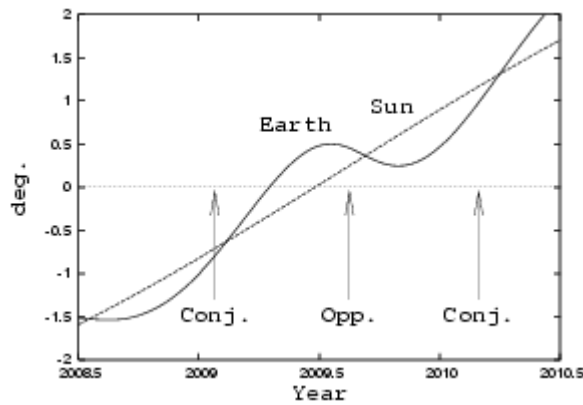

Case of Saturn - 2009

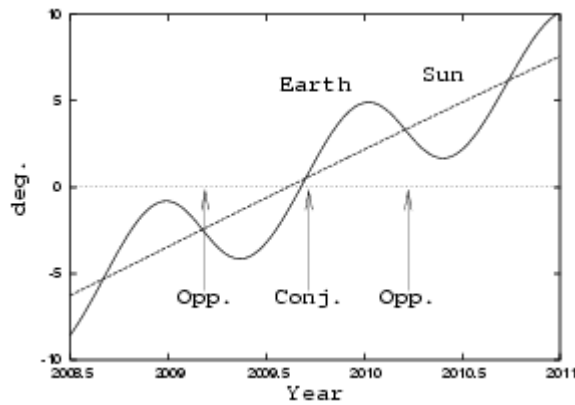

Case of Jupiter - 2015

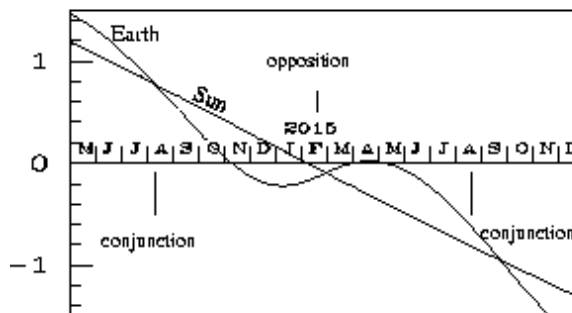

Similar events occur also in the systems of Saturn and Uranus. If the eclipses by the planet are much more difficult to observe than the eclipses by Jupiter because the too small apparent distance between the satellites and the planet at the time of an eclipse, the mutual events are observable. However, the magnitude of the satellites is fainter and the apparent distances to the planets smaller than in the Jovian system that makes more difficult the observations. The principle of observation is the same for all the satellite systems but requires larger telescopes, more sensitive receptors and filters to decrease the brightness of the planet.

The receptors and the filters to be used for the observations

The goal is to record the variation of a light signal and to make a photometric recording depending on the time with a high frequency of acquisition (from 0.5 to 5 points per second of time) to have a good sampling of the event. For that, several receptors may be used from the more simple recording only one signal to the more elaborated recording simultaneously several signal in several wavelengths. These receptors are:

- single channel photometer ;
- spectral multichannel photometer ;
- spatial multichannel photometer ;
- spectrophotometer ;
- two-dimensional receptor (CCD, video).

We will not provide information on the receptors themselves, but only on the problems related to the recording of the events, the wavelengths to be used, the sampling integrated time and the reduction. We will study only the two dimensional receptors since they are widely used nowadays.

a) The wavelength and the filter

The spectral band where the observation should be made depends on several factors: first you have to choose the wavelength where the receptor used is the more efficient; second you may choose a wavelength in which the observation will provide the most interesting information. Note that any wavelength is interesting but we may know what wavelengths are more favorable to reach new information.

In the case of a receptor working in only one wavelength: any visible wavelength will provide useful lightcurves. For a CCD receptor, the R and I bands are more efficient. Note that it is possible to decrease the light from the planet (for events occurring very near the limb of the planet) by using interferential filters such as CH₄, (7260 Å, 8300 Å, ...) even it is not always efficient and need more flux. A larger telescope will be needed. For observations to be made in a city polluted by light, the 5000 to 5300 Å spectral band should be of any interest. The following diagram shows the brightness of the urban sky depending on the wavelength.

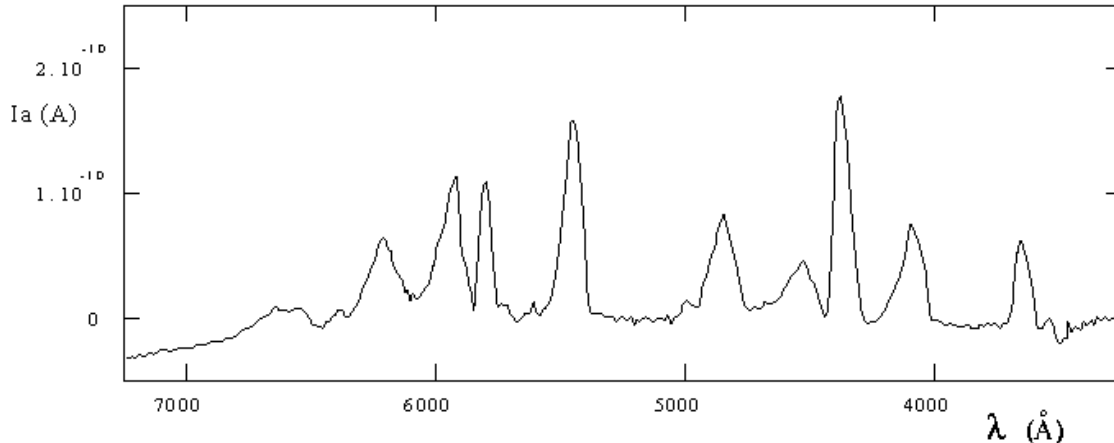

Fig. 1 – Brightness of the sky background versus wavelength (from G. Malinié, thesis Paris VII).

Figure: the sky background in cities

Note that in case of a spectral multichannel photometer, it may be possible to record the event in several wavelengths. It is very interesting since it is the only way to decorrelate local photometric accidents depending on the site and on the observational conditions from interesting information on the grounds of the satellites. Note that the time sampling should be sufficient (more than one point every second of time but not more than 10 points per second). As said previously, all the wavelengths are interesting because of the few experience we have on such simultaneous lightcurves.

b) Integrating time and time sampling

- the integrating time should be not too short (it is necessary to have a sufficient signal/noise ratio) and not too long (since the events are very fast, we need to record enough points to model the light curve). The experience shows that, depending on the receptors, the integrating times vary from 0.1 to 2 seconds of time.

- the time sampling depends on the integrating time : after recording the light during the integrating time, it is necessary to store the date and the value before starting a new measurement. The modern receptors allow to make this operation very quickly. The time sampling is commonly included between 10 points per second of time to one point every 2 seconds. More points will provide too much data for an event of a few minutes duration ; less points will not be sufficient to determine the different phases of the events especially in case of short events. Anyway the time sampling must depend on the duration of the event : for long events (about one hour) one point per second is sufficient.

Be careful to avoid a saturated image: the photometry will not be confident. The Galilean satellites are very bright and they may saturate the receptor just before the occultation: the two objects will become only one spot and the intensity will increase if the seeing was bad spreading the light when the satellites are separated. Several solutions are possible:

- put a diaphragm on the telescope to decrease its aperture
- use a density filter to decrease the light arriving on the receptor
- put slightly out of focus the images to spread the light on the detector

The last solution is very easy to perform even at the last moment. Note that the images may appear not saturated before the event but when the two satellites in occultation will be very close to each other, the image could saturate because of the seeing which avoided the saturation when the satellites were separated.

c) The diaphragm (or working window)

The diaphragm is a window, chosen by hardware or software in the recorded field, containing the object(s) the light flux of which is to be measured all along the event. For example, in the case of an eclipsed satellite, this satellite will be included in the diaphragm and its light flux measured during the event. In the case of an occultation, both the occulted and the occulting satellites will be included in the diaphragm and their light flux measured before, during and after the event. Several diaphragms may be useful in order to record references and the sky background for calibration. This may be complicated by the presence of another satellite in the vicinity of the involved satellite or by the closeness of the bright planet. Several examples will be shown below. Note that you have not to define the diaphragm with a two dimensional receptor such as CCD, but keep in mind that you will have to make a diaphragm by software after the observation for the reduction. Then, put the satellites in the center of the field and keep them at that place in spite of their proper motion (they go fast...). Think that you will have to measure the sky background which may not be uniform because of the vicinity of the planet. You also will need a reference object to detect light clouds decreasing the signal: put them in a good place in your field to be able to measure their flux easily.

The study of the field before each event is now easy thanks to interactive softwares available on www.imcce.fr/sat. Note that in any case a too large diaphragm will include too much light from the sky background leading to a bad signal/noise ratio and that a too small diaphragm will make difficult to catch all the light from the implied satellite in the diaphragm (especially with a bad seeing).

The time-scale for the observations

Since these observations are made in order to improve the dynamical models of motion of the objects themselves, all the data must be referred to a well known time-scale to the nearest tenth of a second of time in order to be able to link all the observations together. In fact, all the observational data should be referred to UTC (Universal Time). Internal clocks of computers are not confident because not linked continuously to UTC. If it is not possible to be connected to UTC any time, it is necessary to verify the used clock before and after the observation and to record the difference between the used clock and UTC at that time (never modify the clock during an observation). The sidereal time must never be used in the present work. We learned, through the past experiences that this calibration of the time-scale should never be made after the observation since anything can happen such as a failure of the hardware. Unfortunately, all the observatories do not have a sure clock related to UTC and the best to do is to note the difference of the available time-scale with UTC before and after the observation by calling UTC through the phone network or thanks to a radio-receiver in order to know if a drift occurs in the time-scale. The time accuracy should be better than 0.1 second of time that is to say that each photometric measurement of the recorded light-curve must be dated in UTC with an accuracy better than 0.1 second of time. Note that the satellite Io, for example, has a velocity of 17.2 km/s, so that an accuracy of 0.1 second of time corresponds to an accuracy of 1.7 km in space. Since the internal accuracy of the theory of motion of the satellites is around one kilometer, anyone may understand that an accuracy better than 0.1 second of time is necessary. Note that the time obtained by GPS is confident.

At last, be careful to start the observation well in advance. The predictions are not so precise and the events could start a few minutes before the predicted time. The long events may begin 10 minutes or more before (or after) the predicted time. Don't forget that predictions are often made in Terrestrial Time which differs from the UTC of about one minute of time (TT - UTC ~ 66 seconds in 2009).

Performing the observation

The observation of the Galilean satellites is easy because:

- they are bright (magnitude 5)
- they orbit far (in apparent angular distance) from the bright Jupiter (until 14 arcmin)

The image below shows the Jovian system in a small telescope.

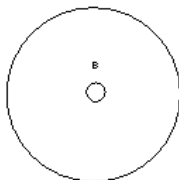

Figure: the Jovian system (field: 20 arcmin)

Even if these observations may seem to be easy, the nights are always too short to make all the preparation to the observation of the events and to allow improvisation : therefore, prepare a written procedure with a well-adapted timing in order to be sure to forget nothing (calibrations, ...).

a) the preparation

During the event, another satellite (or a bright star in the field, that will be very rare) will be used as the photometric reference. This choice has to be made well in advance to the event. Be careful to identify correctly the satellites, especially if you use optical mounting reversing the field. Several cases may occur as shown below for making a window inside which you will measure the flux of the concerned satellite.



Example 1 :

A eclipses B, A far from B during all the event : B will be measured alone.

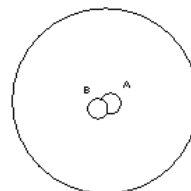

Example 3 :

A occults B. A and B will be recorded together but they should be measured separately as indicated above.

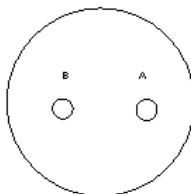

Example 2 :

A eclipses B, but A and B are very close. A and B should be measured together. However, before or after the event, it will be necessary to measure separately the flux of A and B. In some case, it will be necessary to wait in order to have a sufficient separation between A and B.

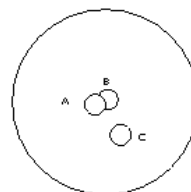

Example 4 :

A occults B, and C approaches A and B during the event. A, B and C will be recorded together but we will measure A, B and C separately after or before the event as indicated above.

By looking attentively the entire recording of the event after the observation and before the reduction, you will know the relative motion of the satellites in order to be sure that none of the satellites will leave the window during the reduction of the event (especially during long events). Note that the magnitudes of the satellites are not well-known especially in non standard spectral bands and that these magnitudes vary depending on the orbital positions of the satellites, so that it is necessary to measure the individual light flux of the satellites before and after the event.

Start the recording of the event well in advance : for long events, an error of 10 minutes of time in the timing is possible.

Be careful to the positions of Jupiter in the sky. The observation is possible even very low on the horizon (less than 10 degrees) except if Jupiter is behind a mountain or behind a building. Therefore, calculate the local positions of Jupiter before the event. Beware the polluting light and the absorption : only the light from the Moon or from Jupiter and the air mass at the time of the observation may be predicted. For the Moon the use of a R or I filter will solve easily the problem. For the light from Jupiter, a narrow filter ``CH4`` may be interesting as indicated above. The sky background has a high gradient near Jupiter and its measurement should be made very carefully. The next figure suggests a way to measure this sky background : measure it symmetrically from Jupiter. Another way is to model the sky background with a two or three degrees polynomial fitted on the images without all the objects but this method is possible only on recorded CCD images.

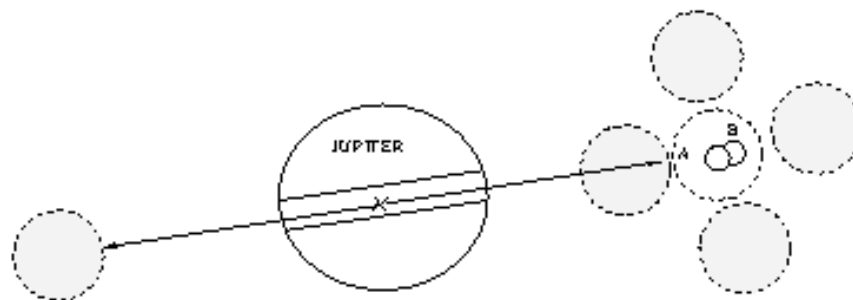

Fig. 2 – Sky background is to be measured in the dashed areas.

The absorption is harmful if it varies randomly during the events (small clouds): the only solution is the use of a two-dimensional receptors and the simultaneous recording of a reference object. Same if the sky background varies (twilight) the use of a two-dimensional receptor such as CCD is recommended.

b) the recording of the event

The measurement of the sky background is necessary in all cases, even if there is no light pollution. It will be continuously recorded in all frames: it is necessary because it may change during an event.

The atmospheric absorption leads to a magnitude drop proportional to the zenithal distance (air mass) as determined by the ``droite de Bouguer''. In fact the absorption may vary considerably from one night to another ; they may vary also during the same night. Therefore the ``droite de Bouguer'' will be no more a ``droite'': the points scatter, mainly near the

horizon. This, to show that it may be useful to make differential measurements referred to another Galilean satellite or to a standard photometric star whose spectral type is quasi-solar.

c) observations to be made cautiously

- Observations made low on the horizon: in that case, be careful with the refraction which increases rapidly and which needs to correct the guiding of the telescope. Be also careful with the absorption which increases and may also vary. The measurement of a reference object is highly necessary simultaneously (CCD two-dimensional detector) or from time to time (if no reference satellite is present in the recorded field) by moving rapidly the telescope to another satellite. The light curve obtained if a motion to a reference object is necessary, is shown in fig. 4. The reference object and the sky back ground have been recorded during the event. Note that in any case, the best is to put all objects in the field of the CCD allowing to measure simultaneously all the interesting objects (and the sky background).

Sequence of observation with a one-channel photometer

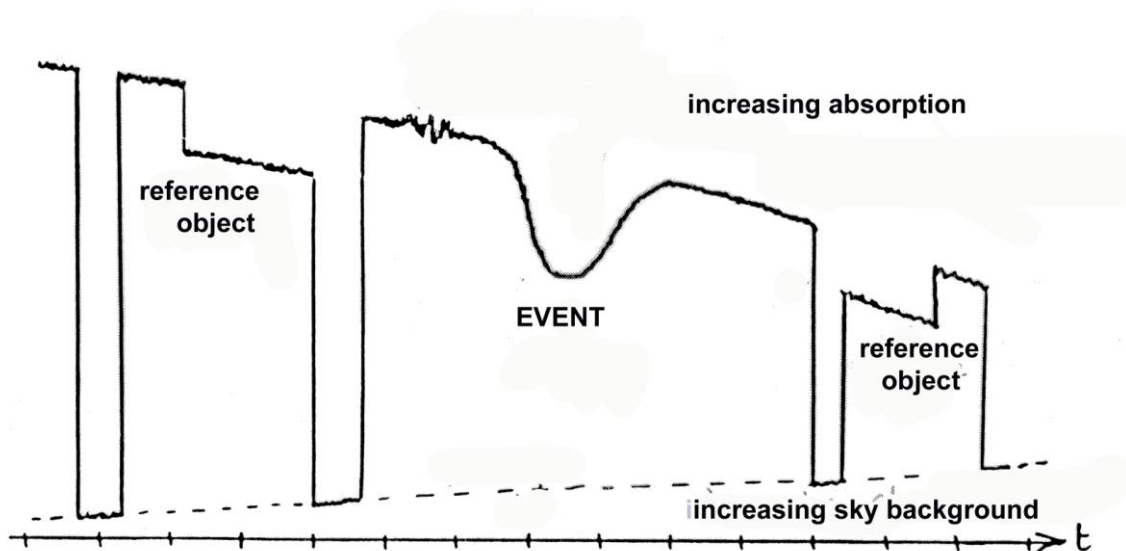

Figure 4: all what is interesting to record during a mutual event

- Observations made during twilight: they are confident if some precautions have been taken. Do not forget that the brightness of the sky doubles every 4 minutes before sunrise. Observing in the R or I band will allow to observe latter in the twilight and sometimes during daylight if Jupiter is far from the Sun. Observing in daylight is possible but difficult because of the very bad seeing as soon as the Sun is risen. The infra red CH4 or K-band filter allows also the observations in daylight. An example of light curve observed in twilight is shown in fig. 5. In the case of an infrared receptor, the sky background is generally subtracted in real time using a 30Hz or 60 Hz oscillating modulator. Observations may be made during daylight if the problem of the guiding of the telescope is solved. The measurement of a reference object is also necessary in that type of observation. In the section “Examples of light curves” an example is provided showing an observation during twilight and through light clouds.

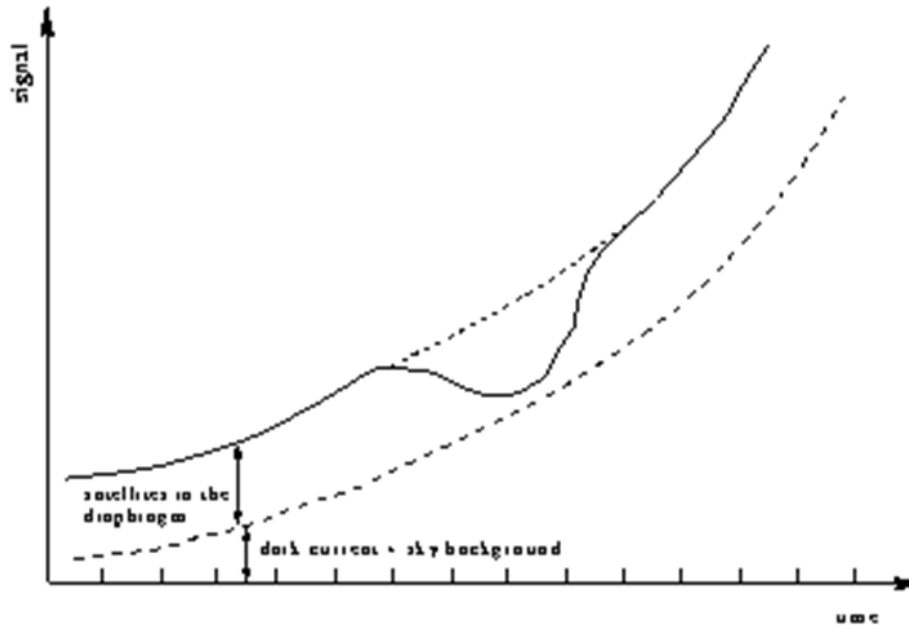
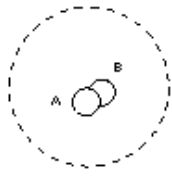

Figure 5

d) the light curves to be obtained

The light curves obtained depend on the way the observation has been made and on the objects included in the diaphragm (the window designed to measure the light flux inside it). What kind of light curves will we get? The figure 3(a) shows the case of an occultation or an eclipse for which two satellites (or more) are included in the window (the light flux drop may never reach zero). The figure 3(b) shows the case of an eclipse for which only the eclipsed satellite is included in the window. Note that the light curves are not always symmetrical. The phase defect, the features on the surfaces and the light scattering may modify the shape of the light curves compared to what will happen with satellites the surfaces of which are uniform. The light curves as shown on fig. 3 have been calibrated thanks to the reference object and the sky back ground: raw light curves may have any shape as shown by fig. 4 and 5.

Diaphragm during the phenomenon



A occults B

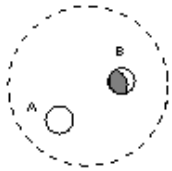

A eclipses B with
A close to B

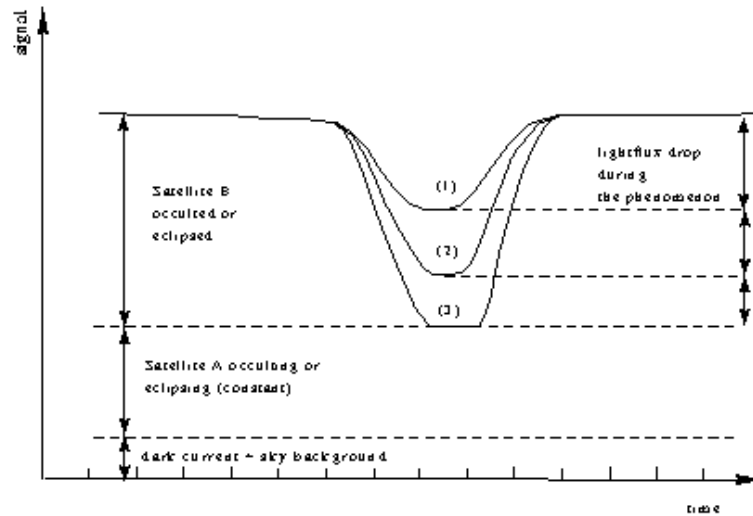

Fig. 3 (a) – occultation or eclipse where the satellites are both in the diaphragm

(1): partial phenomenon

(2): annular phenomenon (the minimum theoretically shows a plateau)

(3): total phenomenon (a plateau appears when the phenomenon is total)

Diaphragm during the phenomenon

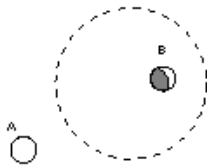

A eclipses B with
A far from B

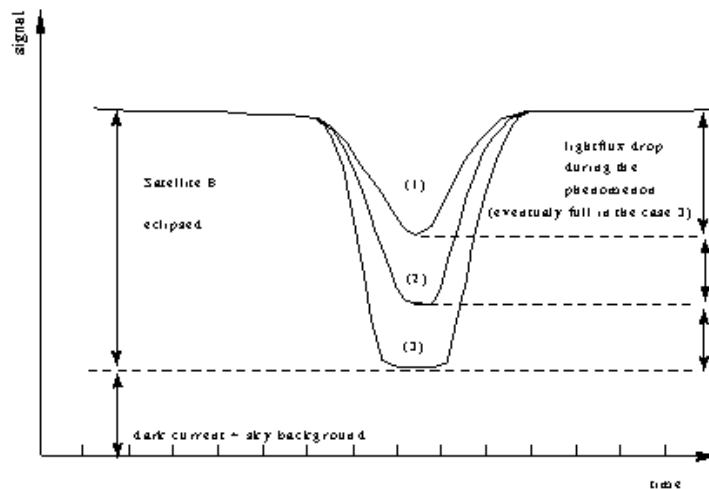

Fig. 3 (b) – eclipse where the eclipsed satellite is alone in the diaphragm

(1): partial phenomenon

(2): annular phenomenon (the minimum theoretically shows a plateau)

(3): total phenomenon (a plateau appears when the phenomenon is total)

e) let's remind the errors to be avoided

- to mix satellites (confusing North/South or East/West...);

- to start observing too late and to have not enough time for the calibrations;

- to miss observations thinking that Jupiter is too low on the horizon: observations are possible at 10 degrees above the horizon, even less...;

- to choose a wrong field and to need to change it during the event;
- to suppose that the motion of the satellites is linear and uniform;
- to think that we know everything on the Galilean satellites (the magnitude may change from one point to another on the orbits);
- to have a wrong time scale and to be not sure of the clock (be sure to have the UTC available);

In brief, prepare carefully the observation and follow minute after minute a procedure written in advance with a precise timing

Summary of the most important points to be examined before the observation

- 1 - be sure to have a time scale in UTC accurate to 0.1 second of time ;
- 2 - verify that Jupiter and the satellites will be visible during all the observation ;
- 3 - verify that each point of the lightcurve is correctly referred to the time scale with an accuracy better than 0.1 second ;
- 4 - think to use the right filter : 5000-5300 A, in an urban polluted site, R or I filter during twilight or near the Moon, CH4 filter with a larger telescope when the planet is too close; but, if possible use a filter designed for the receptor that you use ;
- 5 - if you are not familiar with the material that you use, take a little more time before the observations to know it
- 6 - be sure of the identification of the satellites (beware the optical mounting which reverse the field) ;
- 7 - determine precisely your field and what window you will design for the reduction: the satellites should be inside during all the time of the observation (especially for long events) ;
- 8 - know precisely the motions of the satellites during the events and take into account the refraction when observing low on the horizon ;
- 9 - take into account the presence of the Moon or of Jupiter to prepare the observation ;
- 10 - make individual photometric measurements of the satellites before and after the observation ;
- 12 - be sure to have a reference object in order to measure the atmospheric absorption
- 13 - be careful for the observations during twilight for which a special procedure is necessary.
- 14 - try to observe an eclipse by the planet Jupiter before starting the observation of the mutual events to be familiar to the material and the procedure which may be improved.

The photometric calibration

The transformation of the light into electric charges has been studied in the chapter "CCD". Let us remind some principles of the CCD reduction necessary to get the light curve of a mutual event from the series of images recorded during the event. Note that in the case of a single-channel photometer, the flux of the different windows has been directly recorded during the event and that the making of the calibrated light curve follows the same principles.

a) Offset and dark map:

The first problem is that all the electrons do not result necessarily from a transformation consecutive to the catch of an electron. Indeed the simple thermic excitement produces free electrons. It is so necessary to quantify this production which is variable from a pixel to

another one because of the manufacturing defects. The most effective method consists in acquiring a series of poses realized in the same conditions of exposure time, temperature as in the recording, but in the total darkness. One puts here in evidence one of the crucial points of a good observation CCD which is the necessity of a good thermal regulation of the target. One can make the average of a dozen such images to decrease the effects of the noise of reading. The correction of the thermic noise is made then simply by removing this "offset map" from every acquired image. One will note that in the absence of any thermic electron, the CCD always produces an output signal different of zero. This variable value from a pixel to the other one is called the electronic offset.

Finally with this method, the map which one measures represents the sum the maps of thermic noise and electronic offset. One realizes so these two corrections at one time. Afterward we will speak only about offset map.

b) Flat Field:

The second problem is that the quantum return on every pixel is not constant. It is so necessary to have a map of sensibility of the detector. For that, it is necessary to enlighten the CCD with a calibrated light. If we suppose that the response of the target is linear (what is very close to the reality), an uniform light can be enough. One makes a map of sensibility of the matrix by making the average of a dozen images to decrease the problems connected to the noise of reading. For the correction of an image, one divides every pixel of the image by the corresponding pixel of the image of the Flat Field of uniform light (denoted FF in the following and PLU in french) and one multiplies by the mean value of its FF to preserve the dynamics. It is necessary to realize one FF for each used filter, furthermore as the conditions of observations change each night (temperature, dusts), it is necessary to realize one FF each night of observation.

The problems do not end here! Photons coming from the Galilean satellites passed through various optics which have convoluted the signal. The method most often used is to make FF for the whole system of acquisition; one needs then an uniform source in the infinity. It is not simple to realize! This problem is not yet suitably resolved today. The least bad is certainly to use the sky background during twilight by paying well attention to the problem of undesirable light. Some observers use a white screen placed inside the dome. Besides these problems, it is necessary to realize one FF for each filter and for each night of observation: the conditions of observation may vary from day to day (temperature, dusts...).

c) Method to be followed to calibrate a CCD camera:

In summary, here is the method of photometric reduction:

- 1:** Realize a dozen images of the sky in the twilight. To have a sky background as constant as possible, it will be necessary to point the telescope contrary to the Sun and at an important height above the horizon. Indeed verify that no pixel is saturated and that the average level of the image is equal or superior in the middle of the dynamics of the detector.
- 2:** Realize a dozen images in the same conditions of temperature and of time exposure but in the total darkness.
- 3:** Calculate the Flat Field. For that, make the sum the thorough images of sky, then the average of the offset maps. Remove then from the sum of $N \times FF$, N times the average of the offsets.
- 4:** Just after the observation of the phenomenon, make an offset map in the same conditions of recording as those of the observation (in particular in case of windows, keep the same windows for this map).
- 5:** Finally for every image of the phenomenon it will be necessary to remove the offset map, to multiply by the mean value of the FF, then to divide this image by the FF (1).

$$I(x,y) = (I_{\text{raw}}(x,y) - I_{\text{offset}}(x,y)) * I_{\text{FFaverage}} / I_{\text{FF}}(x,y) \quad (1)$$

we will suppose that the response of the CCD detector is linear. In case of intensified cameras for which the gain function is unknown, it will be necessary to determine a reciprocity function.

Calculation of the light flux of an object

We shall suppose now that the radiometric corrections are realized, i.e. that the intensity of every pixel is proportional to the photons received. It is now necessary to isolate satellites on the image and to calculate their light flux.

a) choosing a window (simulation of the diaphragm of a photometer)

When the sky background is uniform (that is the case, for example, if the satellites are far from the limb of Jupiter), the simplest is to simulate a photometer. It is enough so to calculate the sum pixels situated inside a window centered on a satellite (this window can be squared or circular). One will note S1 this sum and N1 the number of pixels. We will make the same calculation for a larger window around a smaller one. One will have then F1 and M1. We will calculate the sky background on the outer part of the second window (2). The light flux of the satellite is then calculated on the first window (3).

$$\text{Calculation of the sky background: } \mathbf{Bg1} = (\mathbf{F1} - \mathbf{S1}) / (\mathbf{M1} - \mathbf{N1}) \quad (2)$$

$$\text{Light flux of the satellite: } \mathbf{Flux1} = (\mathbf{S1} / \mathbf{N1}) - \mathbf{Bg1} \quad (3)$$

The only problem is to adjust the size of windows. It is not necessary to choose them too small because of the risk of losing a part of the object, nor too big what would add noise due to the too large part of sky. In practice it is necessary to make attempts, and to choose the combination which gives least variations onto the measures.

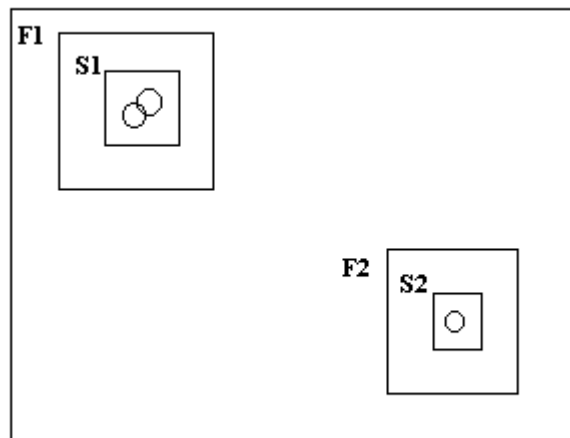

b) use of a reference object for relative photometry

If a reference object is present in the field (generally another Galilean satellites, rarely a bright solar-type reference), we will calculate its light flux for each image. This flux is supposed to be a constant. If Flux2 is the light flux of the reference object S2 calculated as for Flux1, the light flux of the occulted or eclipsed satellite S1 will be:

$$\text{Flux of satellite S1} = (\text{Flux1} / \text{Flux2}) * \text{FM2}$$

where FM2 is the average flux of reference S2 , used in order to normalized the calculated flux of S1.

Then we obtain:

$$\text{Flux of satellite S1} = ((\text{S1/N1} - \text{Bg1}) / (\text{S2/N2} - \text{Bg2})) * \text{FM2}$$

This technique allows to observe events in difficult conditions: proximity of Jupiter (the background Fond1 and Fond2 may be very different), variation of the absorption or transit of light clouds (Flux1/Flux2 remains a constant), twilight (the sky background varies exponentially but is removed from each image). One will see the light curves corrected thanks to this method below in the section “Examples of light curves”.

c) ajustement of a gaussian curve

A second method consists in the adjustment of a mathematical profile of gaussian type (4). The total flux of the gaussian can be reckoned then simply (5).

$$\text{Gaussienne} \quad I(r) = I(0) \exp(-R^2/\hat{A}^2) \quad (4)$$

$$\text{Flux total} \quad \text{Flux} = \hat{A}^2 I(0) \quad (5)$$

The function is fitted by a least-square method. However this method works well if the image of the satellite is big enough (width halfway up superior to 3 or 4 pixels). Furthermore if the images are good quality, as the visible diameter of satellites is not unimportant, the image of the satellite has necessarily no gaussian profile. This is particularly true for the image of two satellites in the course of a mutual occultation. This method, adapted well to stellar profiles is more complex and doubtless less successful than the simple photometric measurement of the total flux in a simulated diaphragm for the observation of the mutual phenomena.

d) calculation of the light flux when the background sky is not spatially uniform

It may occur that the sky background is not uniform. Indeed, the closeness of the limb of Jupiter, the figures of diffraction of the support of the secondary mirror or the twilight can perturb in a important way the uniformity of the sky background. The method of photometric measurement of the flux through a simulated diaphragm reaches here its limits. It is then necessary to adjust a mathematical surface on the sky background, then to remove it from the image to realize a synthetic flat background. As the photometric response of the CCD is linear, one can then use the previous methods. The adjusted surface is often a polynomial of degree 3. The observation of these "difficult" phenomena is certainly one of the big interests of the two-dimensional CCD observations.

e) direct astrometry before and after the event

For the occultations, one can also make an astrometric reduction to measure the relative positions of both satellites during the time when they approach one of the other one, and then when they go away. For this, it is necessary to observe for a long time before and after the

phenomenon (45 minutes at least). Indeed, when satellites are very close, it is impossible to separate them. The cadence of acquisition can be reduced to 1 or 2 images per minute of time. To calculate the centre it is necessary to have a flat uniform sky background. So, as for the photometry to remove a synthetic background if needed. One can locate the satellite by taking into account only pixels above an equal level for example in the value of the background of sky more 4 - 5 times the standard deviation of the background noise. Once these pixels isolated, it is easy to calculate their centre of gravity or to adjust a gaussian surface. The astrometric calibration is delicate. However the determination of the time of the minimum of distance between both satellites is possible without calibration. The minimum of distance can be calculated by adjusting the scale on the velocities of the satellites which are better known than the positions. To have positions enough precise, the focal length the instrument should be at least 10 metres.

Example of light curves

In order to make aware the observers of what type of data they are going to obtain, we propose to have a look to some light curves obtained during the former campaigns of observations. We will analyse what was obtained depending on the receptor or on the observational conditions. We will see how to determinate if the observation is worth being used latter for theoretical purpose.

First let see two light curves of the same event: the light curve at left is that you should get from an observation of a mutual event. The light curve at right is that you should not get!

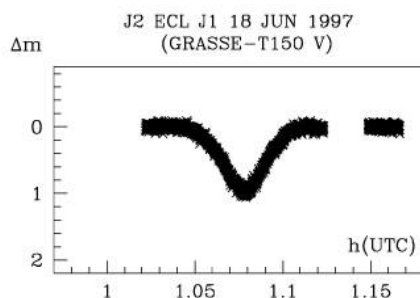

The light curve presents a good signal/noise ratio. The integration time is small due to the large size of the telescope (150cm) but may be increased with a smaller telescope.

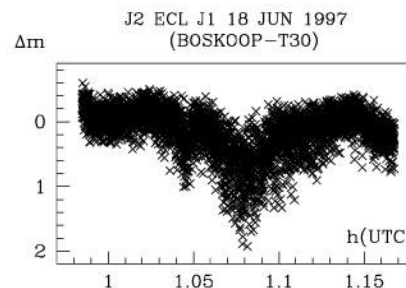

The light curve presents a bad signal/noise ratio due to the agitation of the image in a too small diaphragm and the integration time for each point is too small. Light clouds may also be present at the time of the observation.

How to be sure to get the good one? We will show how to have a good use of the receptor and a good adaptation to the local atmospheric and meteorological conditions.

a) Deep light curves (non grazing events)

Each event is associated to a specific magnitude drop which may vary from 0 (grazing event not observable) to 1 (total event, for example total eclipse of a satellite by another). In fact, the light curve provides the flux received from the only concerned satellite when it is possible, and from two or more satellites either for the occultations (we observed the two concerned satellites together) or for eclipses (in case of the proximity of a satellite to the eclipsed satellite). In the tables, we calculated the magnitude drop considering that we observe only one satellite for the eclipses and two satellites for the occultation.

The result is that each light curve is characterized by its magnitude drop, more than by the nature of the event (occultation or eclipse). We may make a classification leading to consider

that an event, the magnitude drop of which is less than 0.1 (10% extinction) is grazing. Let us first consider the non grazing events which are easier to observe, to reduce and to analyse.

1-*The signal/noise ratio and the integrating time of each point of the light curve*

The examples of light curves presented here, show that the noise of the light curve may be very different from an observation to another. How to optimize the observation and to reduce the noise? The noise depends of several parameters:

- observational conditions: the light measured inside a diaphragm may vary because of the bad seeing of the images (scattered light out of a too small diaphragm) leading to a bad signal/noise ratio. In that case, the solution is to increase the size of the diaphragm.
- measurement of the light flux: the light is measured inside a too large diaphragm and the sky background is too high (and it may vary, reducing the signal/noise ratio). In this case, decrease the size of the diaphragm.
- integrating time: the light flux is integrated during a too short time and the scintillation due to the atmosphere will lead to a large variation of the light flux from one point to another point of the light curve. In this case, increase the integrating time but be careful to keep enough points in the light curve in order to have a good fit during the reduction.

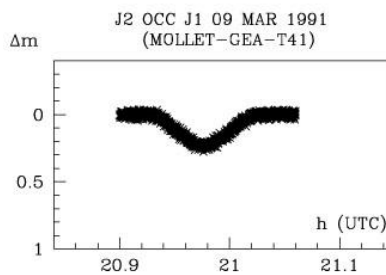

Lightcurve of small amplitude well recorded with a small telescope and a good integrating time

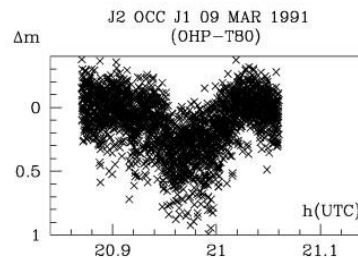

Same with a bad signal/noise ratio due to a too short integrating time in spite of the use of a larger telescope

The example above shows what to do and what to avoid. The left curves have been made using a similar sampling of 0.4 second but with a smaller integrating time at right. The dead time between two recordings was too long.

The results are as follows:

	Mollet GEA T41	OHP T80
Time of the minimum	20h 58m 36s +/- 7s	20h 58m 23s +/- 53s
Magnitude drop	0.226 +/- 0.018	0.382 +/- 0.204

The results are coherent but the bad light curve has larger errors. So, be careful when choosing the integrating time...

2- *The shape of the light curves*

Each light curve contains many informations. The shape of the light curve is one of these informations. Since the disks of the satellites are not uniform, the shape of the light curves is not symmetrical. Only in some cases, the disks are sufficiently uniform to lead to symmetrical light curves. The examples presented here, show that the light curves may be not symmetrical or

may present a flat bottom (mainly in case of annular events).

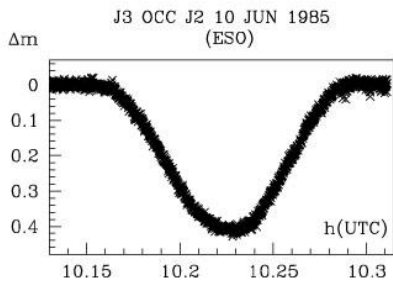

Non-symmetrical lightcurve due to the phase defect..

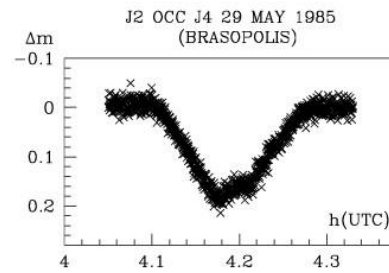

Non-symmetrical lightcurve due to surface effects.

Below, good lightcurves: the light curve from an eclipse and one from an occultation. The edge are sharper for an occultation because of the penumbra in case of an eclipse. Be careful: start the observation well in advance in order to be sure to get the beginning of the light curve especially in case of an eclipse.

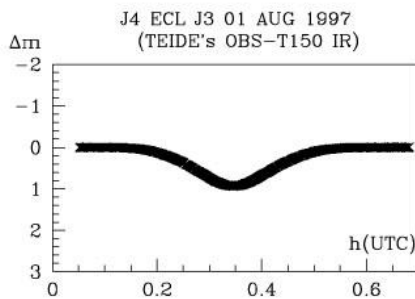

The beginning and the end of an eclipse is smoother than for an occultation

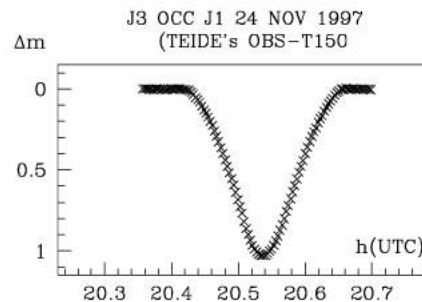

The beginning and the end of an occultation is sharper than for an eclipse

3- The calibration of the magnitude drop

A light curve is, in fact, a series of timings, each one associated to a light flux level. The unit for the dates is the time and should be carefully referred to Universal Time. For example, seconds of time starting from a given date in UTC. The unit for the light flux is very important and should be carefully calibrated. In fact, we need to know the flux received from the satellite(s) for each point of the light curve. The scale should be in light flux assuming that no light from the satellite(s) corresponds to a zero flux. The calibration should be relative and it is necessary to provide the flux of the sky background and the flux of the satellite(s) before and after the event. However, comparing several observations of the same event leads to some inconsistencies: the magnitude drop of the same event may be very different. In this case, the photometric calibration has not been done carefully and the receptor may be not well calibrated. The examples provided below show such inconsistencies. Note that the raw data are provided in flux units (0 to 1) since the reduced light curves are provided in magnitude units (0 to ∞).

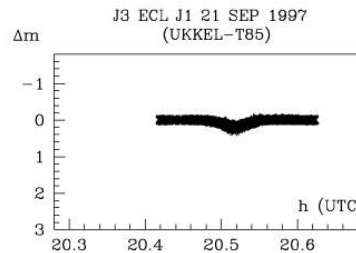
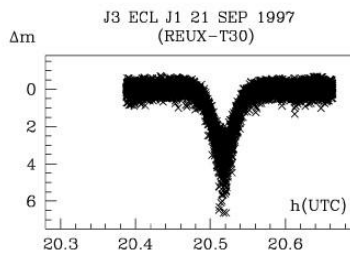
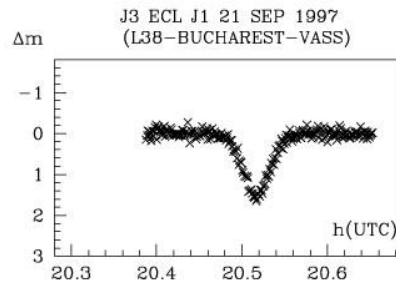
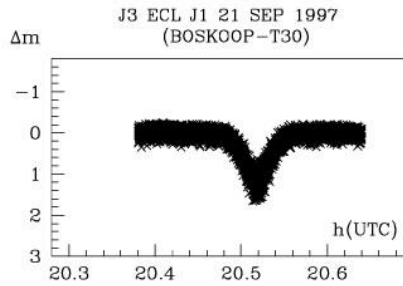

The four lightcurves above concern the same event: unfortunately, if the timings are coherent, the magnitude drops are completely different... This is due to a bad calibration of the photometry of the observation. The flux zero and the sky background were not noted. Below an example of a total eclipse: the flux becomes zero and the magnitude drop, measured in magnitudes is very large.

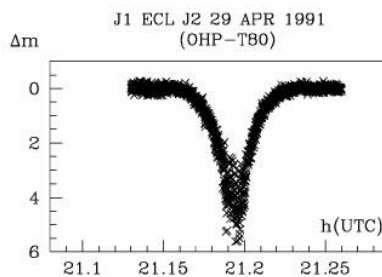

Total eclipse: the magnitude drop increases dramatically

4- The calibration in time

Each point of the light curve should be referred to UTC through radio signal, GPS or internal clock verified just before and just after the event. This is not so easy and you should avoid the example below. All observational sites measured the maximum of the event at the same time except one site the timing of which is different from the other of several minutes of time. The observation will be useless.

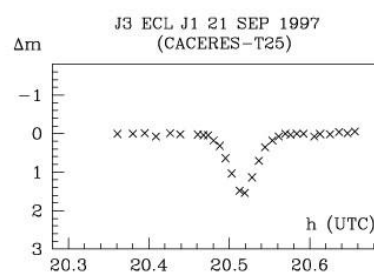
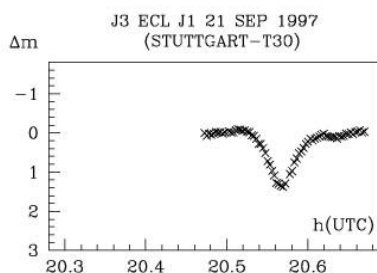

For this event, the maximum appears to be at 20.57 hours UTC The maximum of the same event appears to be at 20.52 hours UTC

One of those two observations has a wrong timing: a third observation is needed to state which one is to be rejected.

5- The fit of the light curves: the sampling of each light curve

The goal of the reduction is to fit the light curves to a model in order to transform the photometric data into astrometric relative positions. It is necessary to avoid a too small sampling of the light curve in order to get enough points for the fit. The examples below show several attempts of fit of some light curves.

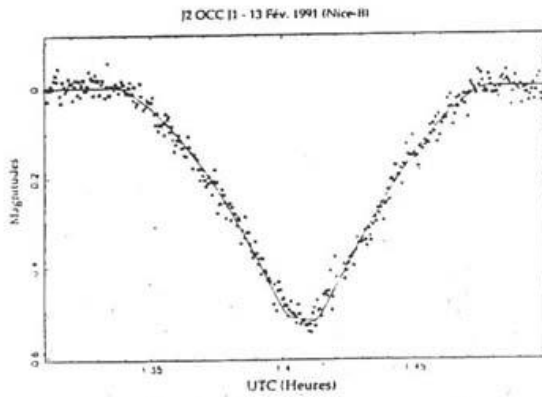

Symetrical deep lightcurve with the fit

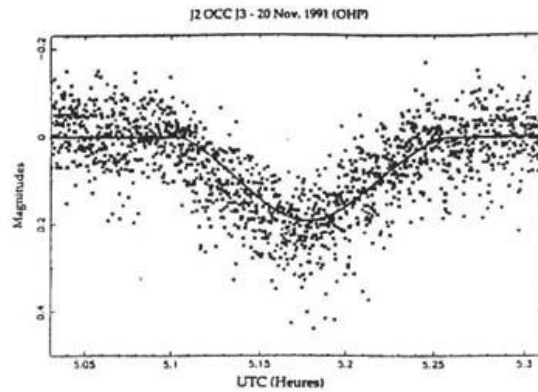

Other symetrical light curve with a worst signal/noise ratio and its fit

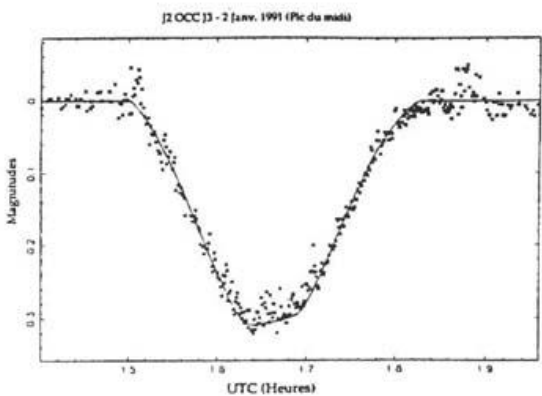

Non-symetrical lightcurve well fitted by the theoretical model.

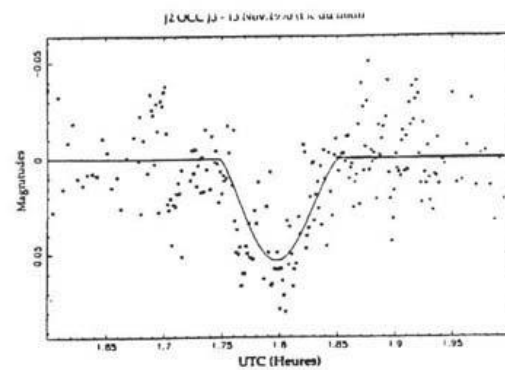

Grazing event with the fit based upon the theoretical model.

b) The faint light curves

The signal/noise ratio

Grazing events with a small magnitude drop may be interesting too. All the problems shown above have to be solved imperatively. If not, the light curves will not be useful. The examples below show the same problems than for deep light curves. However, they may be solved and good light curves may be produced.

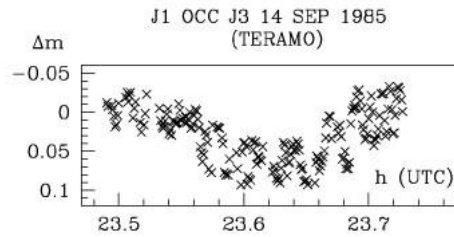

Grazing event: poor signal/noise ratio: however, the observation is sufficient to detect the event.

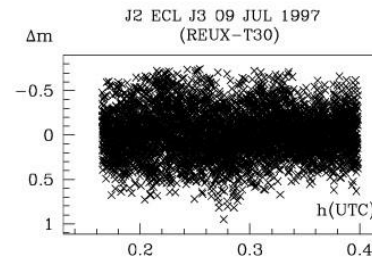

Grazing event: the magnitude drop is very small and difficult to measure because of the too small signal/noise ratio.

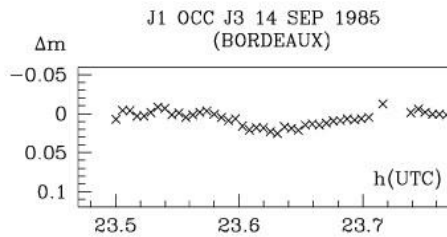

Grazing event: not enough point to have a good determination of the shape of the lightcurve.

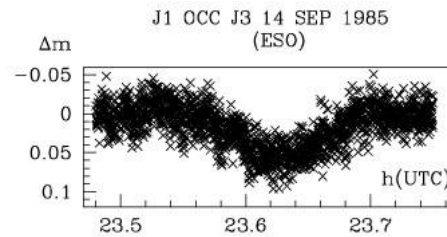

Grazing event: the magnitude drop is very small but easy to measure because of the good enough signal/noise ratio.

c) The influence of the receptors

1- *Sampling of the light curve*

The choice of the sampling of the light curve depends on the receptor. We have to determine the acquisition of the receptor: start of the integrating time, end, reading of the measured light flux, start of the next measurement, and so on... The dead time dedicated to the reading of the measured light flux may be as small as possible. The examples below show the light curves obtained with several sampling. Note that the sampling may be reduced afterwards by software.

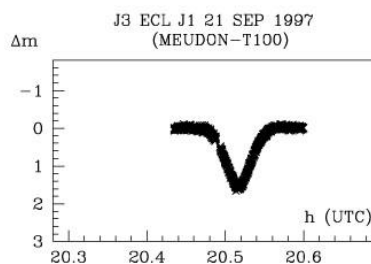

Lightcurve with a sufficient sampling in order to fit a model to the lightcurve.

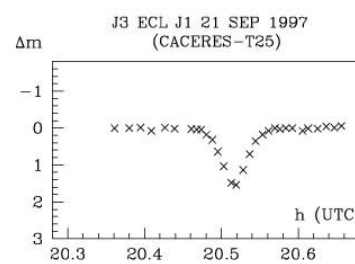

The sampling is poor but allows a fit of a model to the lightcurve.

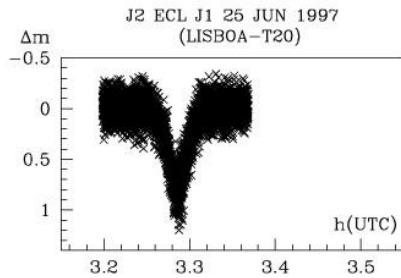

Too large sampling, unuseful. The number of points may be decreased numerically by sum of successive points.

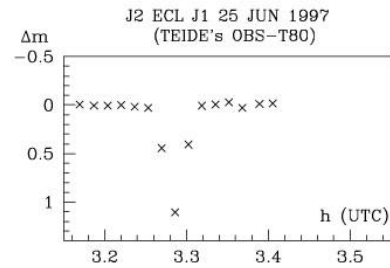

Too poor sampling: the lightcurve is not well-defined.

2- Which receptor is the best?

In fact, any fast photometric receptor may be used for the observation of the mutual events. Fast means that it will be possible to get enough points for the light curve. The sampling of the light curve will depend on the duration of the event. The examples below show the influence of the number of recorded points depending on the duration of the events. Another necessity during a photometric observation is to record reference objects for comparison. We will see in the next paragraph that the two-dimensional receptors are very efficient for that.

We show several examples of light curves made either with a single channel photometer or with a CCD receptor. We show also observations made with other types of receptors, even visual observations for comparison.

In any case, the use of a two-dimensional CCD receptor is the best way to succeed (and the Water camera allowing to have from 25 images per second until one image every 5 seconds of time)..

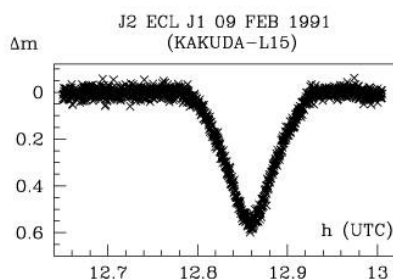

Hamamatsu R647 1P21 photoelectric photometer 15cm refractor, 1 point per second

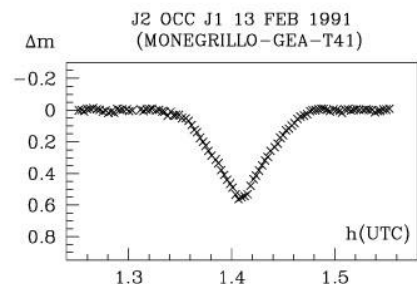

Optec photodiode SSP13 photoelectric photometer 41 cm reflector, 1 point per 10 seconds

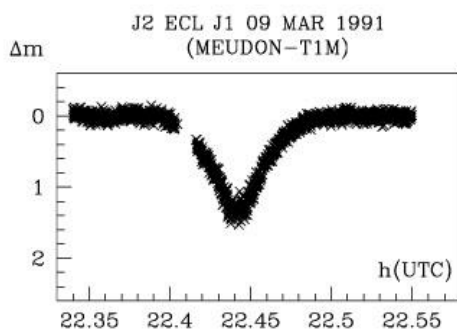

Video Imaintel CCD camera + VCR

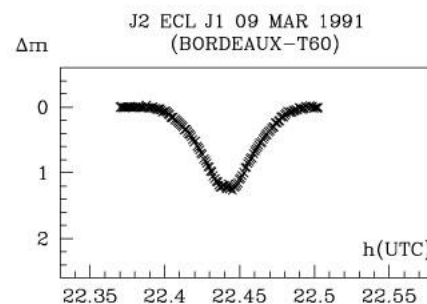

Cooled CCD receptor with TH7852 target 60 cm reflector, 1 point per 1.5 second

1m reflector, 10 points per second

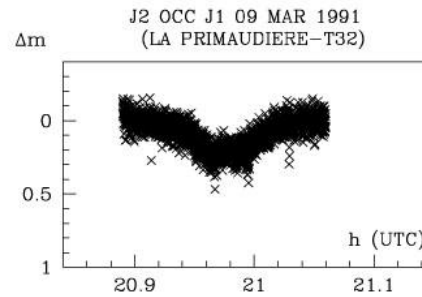
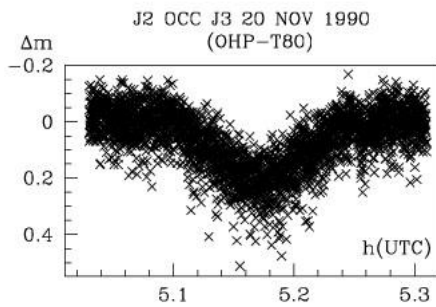

Intensified uncooled video camera (S20 cathode) + VCR 80 cm telescope, 10 points per second

Video camera + VCR 32 cm telescope: 10 points per second

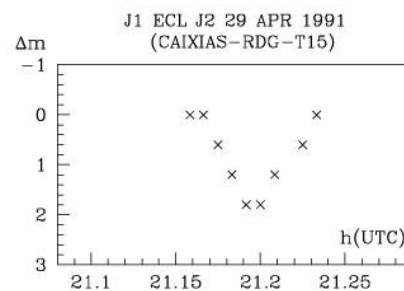
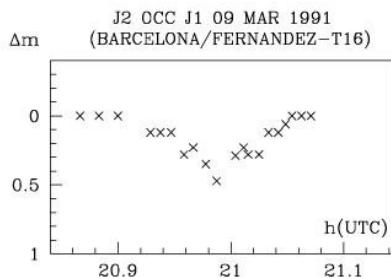

Visual observation with a 16 cm reflector using the Argelander method to estimate the light flux: the maximum of the magnitude drop is well defined but the magnitude drop itself is not.

Photographic technique with a 15 cm reflector: the photometric measurement is possible only for long events: 1 point per minute

d) The influence of the transparency of the sky

1- *The light curves recorded with bad meteorological conditions*

Since we do not choose the time of the observation, clouds may arrive during the observations. Several cases may occur. The best case is the transit a "small" cloud, occulting a small part of the light curve which may be interpolated (this happens also when interrupting the observation to record the sky background or a reference object). A progressive absorption will lead to a light curve needing to be recalibrated assuming that the light level of the satellite is the same before and after the event. A model of the absorption has to be fitted and subtracted from the observation. Examples are provided below.

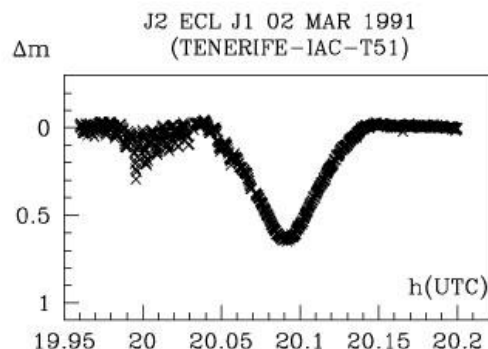

Case of a lightcurve made with some light clouds
disappearing after the beginning of the event

2- The use of the two-dimensional receptors to compensate the bad meteorological conditions.

The use of a two-dimensional receptor is a powerful tool in order to make observations with bad meteorological observations and during twilight. The next example (J-1 eclipses J-2 on April 22, 1991, Meudon observatory) shows what we are able to do in such cases: at left the recording of the eclipsed satellite without and with the background (it was twilight) and at right the same with a reference object (light clouds were passing over the site). The combination of these measurement allows to get a good lightcurve of the event.

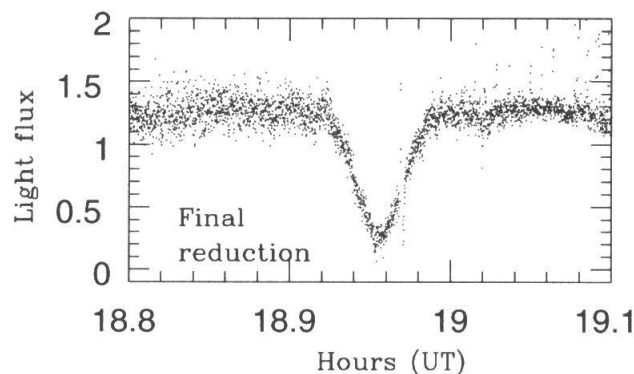
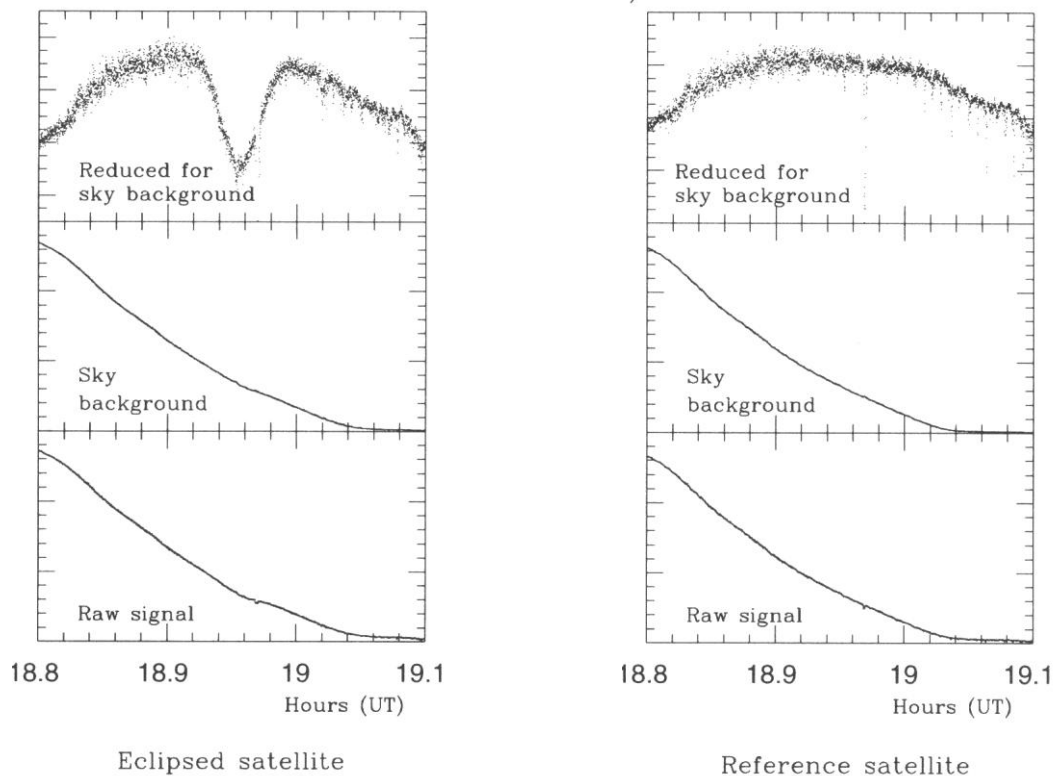

e) Some problems occurring during the observation

The light curves below show an interruption during the event. In fact this may occur for several reasons: some problems in the receptor and recording system; a stop of the guiding of

the telescope needing to find again the occulted or eclipsed satellite ... If the interruption is short, the light curve will be useful. If only the maximum of the event is recorded, the calibration will not be possible except if the satellite outside the time of the event is recorded. However, such a partial observation should not be rejected but kept in order to check the time scale for the light curve of the same event made in another observational site.

In some case, the interruption is made intentionally in order to record the sky background, or the reference satellite. This has to be made when the recording is made only for the occulted or eclipsed satellite without a simultaneous reference and only in case of very long event (more than half an hour) in order to measure the absorption or the sky background if they are changing rapidly (twilight, fog, ...).

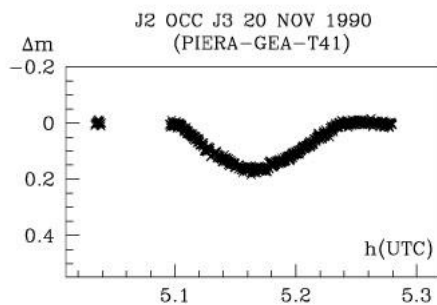

The lightcurve has been interrupted before the beginning of the event: be careful to start the recording of the event sufficiently in advance!

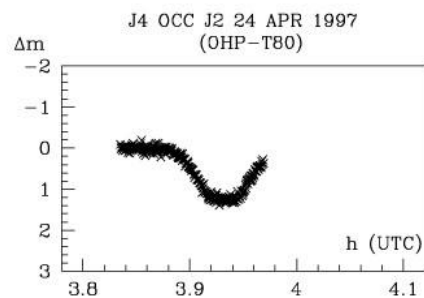

The lightcurve has been interrupted too soon and it will be difficult to determinate the end of the event..

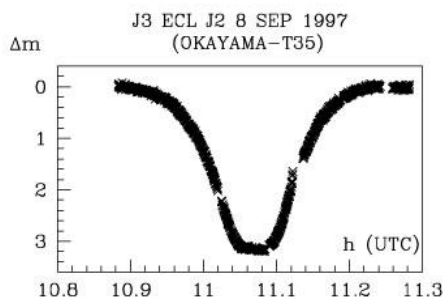

This observation has been interrupted for technical reason; however, the fit of the lightcurve will be possible after eliminating the wrong points.

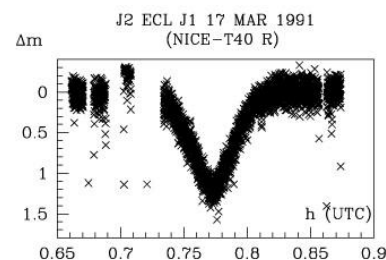

Numerous interruptions for the measurement of references and background: be carefull of the beginning of the event which may occur sooner than predicted.

f) Some very specific lightcurves

The light curves presented below are rare and will be difficult to reduce and to fit to a model.

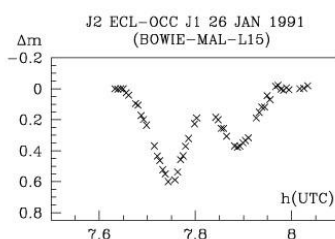

Double event: the occultation starts before

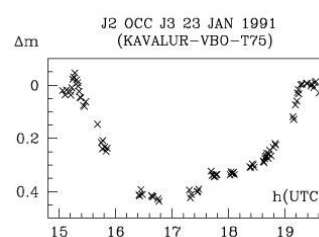

Very long event (more than 4 hours): it

the end of the eclipse

is difficult to keep a good photometric accuracy during so much time.

g) The problems related to the sky background

We have seen above how to deal with the changing sky background and the changing transparency of the sky. The closeness of the bright planet may impose a sky background with a high gradient from one side of the image to the other side. It is then necessary to fit a two or three-dimension second order polynomial on the background (after removing all the objects of the image).

h) The infra red observations and the volcanoes of Io

One of the more spectacular result of the observation of a mutual occultation has been the observation of the volcanoes at the surface of Io, the first satellite of Jupiter. This possibility have been deduced from the analysis of the flux emitted by the satellite Io. The diagram below shows the flux emitted by Io in the infra red wave lengths. In the short infra red, just after the visible (bands I, J, K), the flux emitted by the Sun and reflected by the satellite decreases.

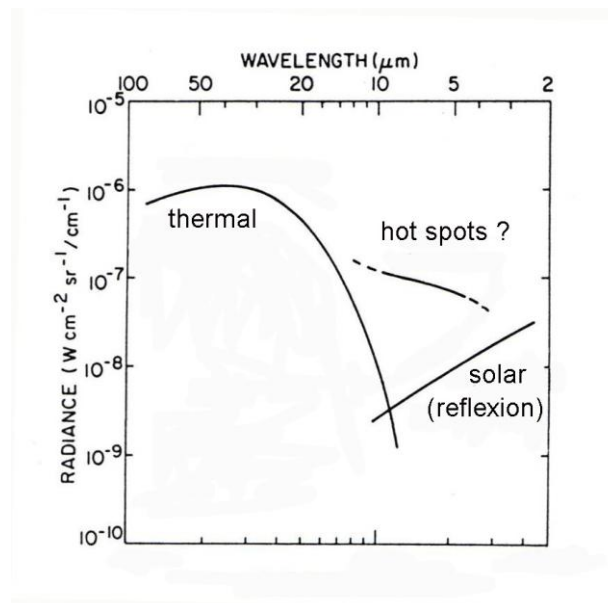
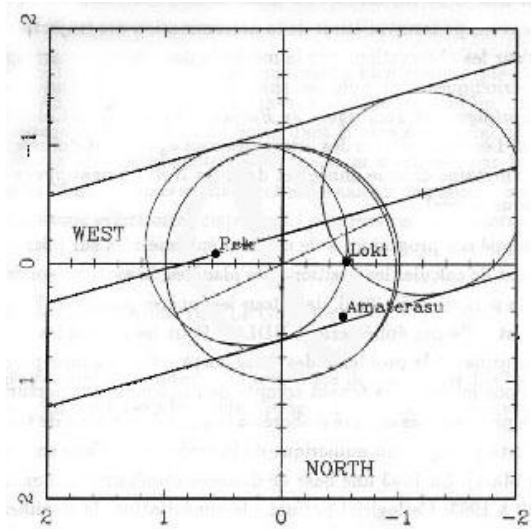
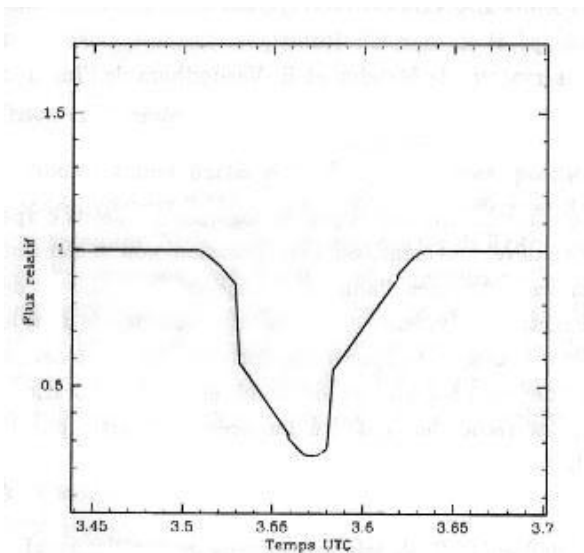

Figure: the emittance of Io

The thermal emission of the surface of the satellites heated by the Sun, started only at 10 micrometers. Between these two spectra, only hot spots on the surface on Io can be emitting. Due to the temperature of the volcanoes, at 3.6 micrometers, only the hot spots are visible. So, an occultation of Io at this wavelength will show only the volcanoes. The light curves below shows the result of the observation. The activity of the volcanoes is measurable as its position on the surface of the satellite.



Left, the configuration of the satellites at the time of the occultation: Europa, the smaller, passes in front of Io, arriving at right. The volcano Loki is occulted first.



The model of the variation of the flux : the occultation of Loki, first, leads to a fast magnitude drop.

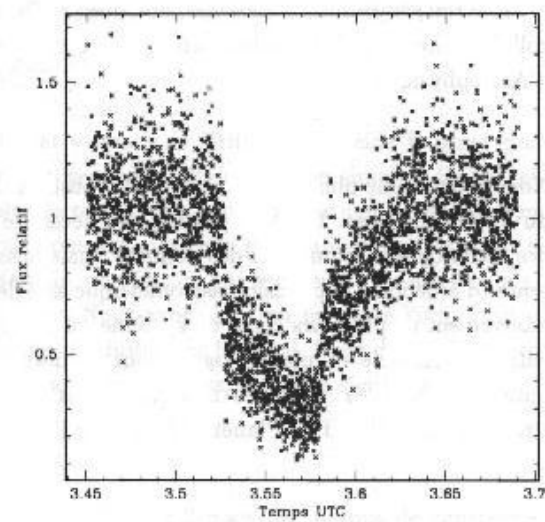

The observed variation of the flux : the occultation of Loki is easily observable.

The mutual events of the satellites of Saturn

All this information may be applied to the satellites of Saturn. However, the observations are much more difficult since:

- the satellites are fainter (magnitude 8 to 14)
- the satellites seem to be closer to the planet since Saturn is at 10 astronomical units from the Sun and Jupiter at 5.

The image below shows the main satellites of Saturn in a mid-size telescope (1-meter).

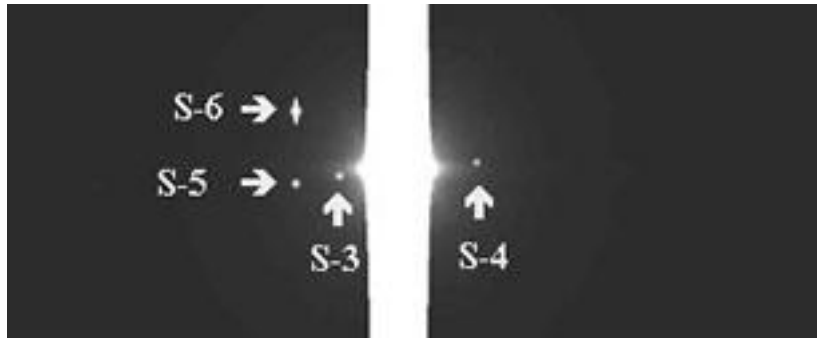

Figure: the system of the Saturnian satellites (field: 6 arcmin)

With such a field, the observations of mutual events should be made using a CCD receptor to get images that will be analyzed afterwards in order to extract the flux of the satellites. Note that for this system the use of a CH₄ infra red filter may not be useful since it will darken the planet but not the rings which are very bright.

The mutual events of the satellites of Uranus

Same with the satellites of Uranus: same events, same techniques but with much more difficulties. Uranus is at 19 astronomical units from the Sun and the satellites seem to be very close to their bright planet. In this case, the use of a CH₄ filter (2.2 micrometers) darkening the planet is very useful but the faintness of the satellites (magnitude 14 to 16) will make a large telescope necessary. The figure below shows the Uranian satellites as seen from different telescopes.

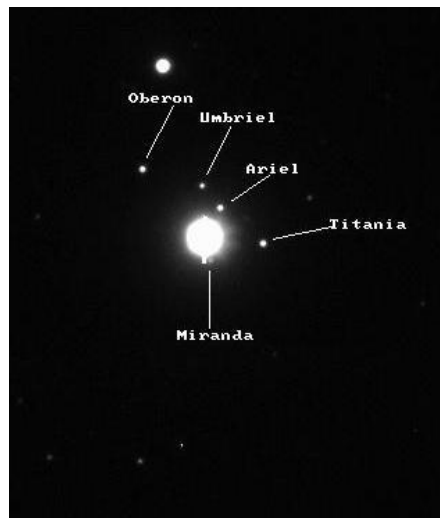

Figure: the satellites of Uranus observed in the V-band on a 1-meter telescope (field: 2 arcmin)

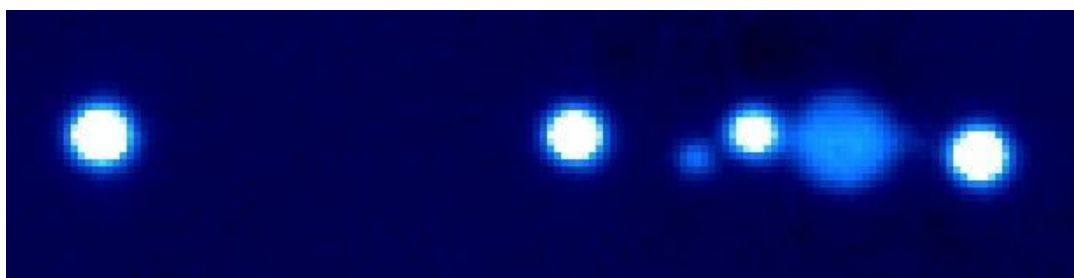

Figure: the satellites of Uranus observed with a CH₄ filter on the NTT 3.5-meter ESO telescope (Uranus appears very dark at right) © ESO/NTT; obs.: F. Colas

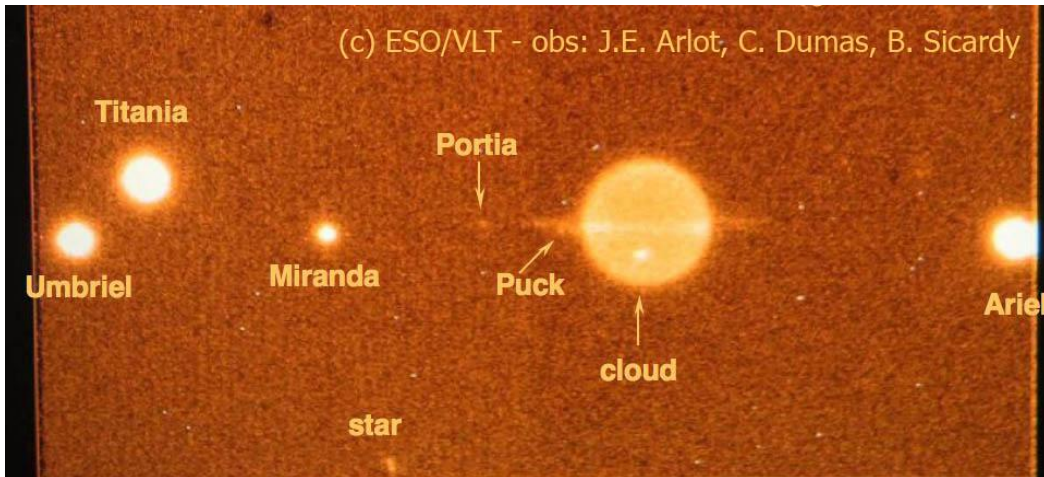

Figure: the satellites of Uranus observed with a CH₄ filter and adaptive optics on the ESO-VLT 8-meter telescope.

The figure below shows a light curve of an eclipse of Titania by Umbriel taken at the VLT 8-meter telescope. The signal/noise ration is very good due to the size of the telescope and to the receptor used.

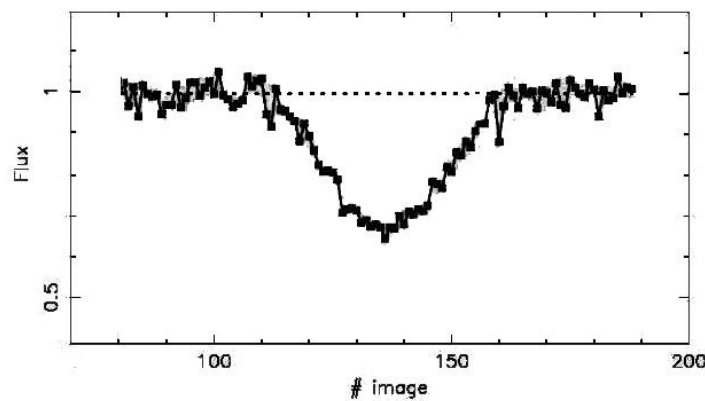

Figure: U-2 eclipses U-3, observed on the VLT

The astrometric accuracy of the mutual events

How to determine the astrometric accuracy of such observations. After reduction, we saw that the residuals are very small compared to other observations. The accuracy of such events is measured in kilometres, not in geocentric angle, so that the accuracy is better as the objects are far from the Earth. The signal/noise ratio is important to allow the determination of the minimum of distance, beginning and end of the event, in fact to allow the determination of the parameters when fitting the theoretical photometric light curve on the observed one. However, an accuracy on the timing of 0.1 second of time corresponds to an astrometric accuracy of 1 km supposing that the velocities of the satellites are about 10 km/sec. The table below show compared accuracies in kilometres and in angles for the three systems of satellites, taking into account the different signal/noise ratio depending on the magnitude of the satellites. The use of a larger telescope for the fainter satellites may provide a similar signal/noise ratio for all objects.

Kind of observation	Accuracy in mas	Accuracy in km
Eclipses by Jupiter	150	450
Old photographic plates	100	300
Transit circle	60	180
Plates newly reduced	50	150
CCD observations	40	120
Mutual events	15	45

Galilean satellites of Jupiter

Type of observation	Accuracy in mas	Accuracy in km
Automatic transit circle	30	200
Photographic plates	100	600
CCD observations	30	200
Mutual events	5	30

Main satellites of Saturn

Kind of observation	Accuracy in mas	Accuracy in km
CCD observations	40	400
Mutual events	6	60

Main satellites of Uranus

The inversion of the light curves

Determination of a longitude shift in the motion of the satellites

The first parameters available are the timing of the minimum of the light curve and the magnitude drop. Note that the time of the minimum of the light curve differs from the time of the minimum of apparent distance between the concerned satellites. A correction is to be made mainly for the phase defect as seen in chapter "Photometry of the surfaces".

It is not possible to deduce some information about each satellite separately from only one observation. We are only able to determine a relationship between the two drifts in longitude through the following equation. We have:

$$a_2 \Delta l_2 \cos \phi_2 - a_3 \Delta l_3 \cos \phi_3 = (a_2 n_2 \cos \phi_2 - a_3 l_3 \cos \phi_3) \Delta T$$

where:

a_2 and a_3 are the semi major axes of satellites number 2 and 3

n_2 and n_3 are the mean motions of the same

ϕ_2 and ϕ_3 are the heliocentric synodic longitudes of the satellites for an eclipse of satellite 3 by satellite 2

they are the geocentric synodic longitudes of the satellites for an occultation of satellite 3 by satellite 2

delta l2 and delta l3 are the shift in longitude explaining the shift of the event in time
 delta T is the C-O (calculated time of the minimum minus the observed one) of the date of the
 minimum of apparent distance. The time of the minimum of flux must be corrected of the
 phase effect in order to become the time of the minimum of apparent distance.

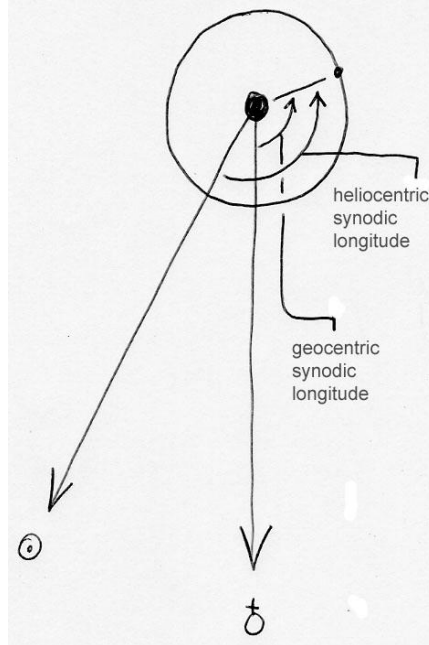
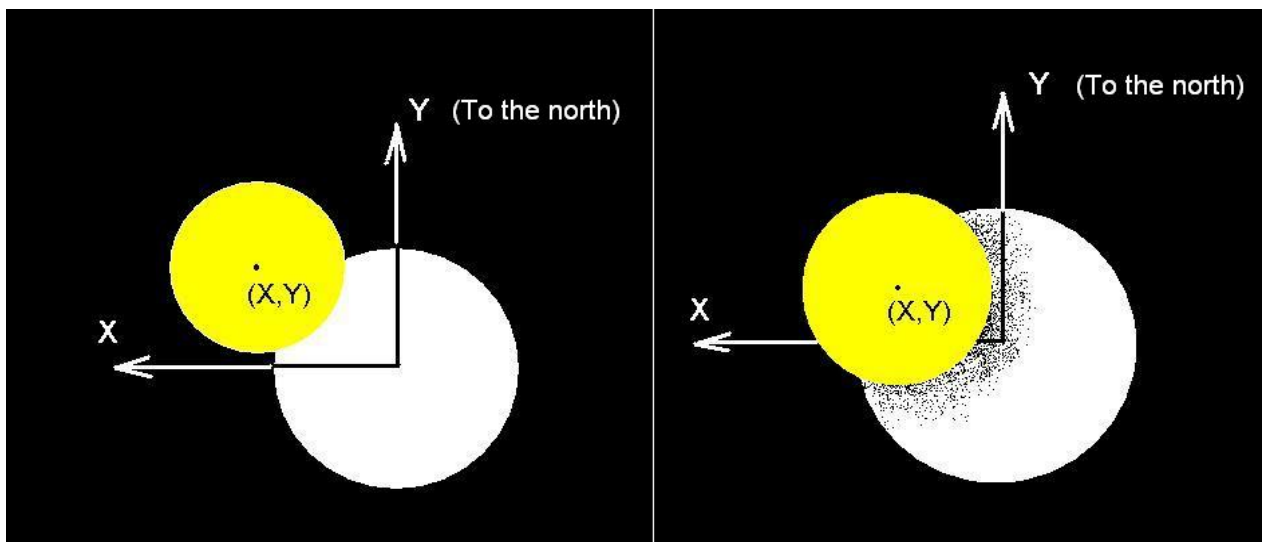

Figure : the synodic longitudes

The complete photometric model

a)the flux



The left side shows the satellites during an occultation as seen from Earth. The eclipse is an occultation of the Sun as seen from the eclipsed satellite and the astrometric data will be the apparent distance between the satellites as seen from the Sun (except that the light time are not calculated as when seen from Earth). X and Y are the tangential coordinates of a satellite referred to the other. This is the astrometric data to be deduced from the observation.

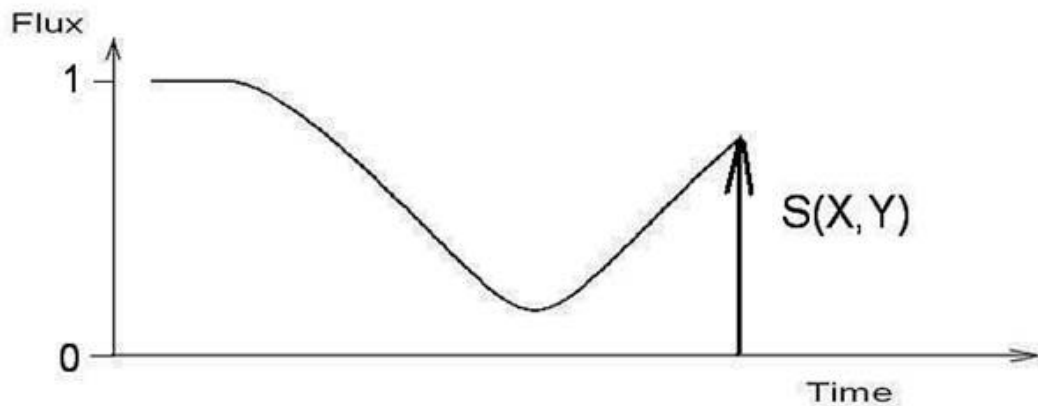

Then, the flux emitted by the observed satellites will depend on the X and Y relative coordinates of the satellites. $S(X,Y)$ is the normalized flux received from the satellites supposed to be equal to 1 outside the phenomena (two satellites separated). We will modelized the function S thanks to the photometric properties of the satellites and then we will have:

$$E(t) = K \cdot S(X_{th}(t) + D_x, Y_{th}(t) + D_y)$$

Where $E(t)$ is the measured flux recorded during the event.

K is related to the characteristics of the receptor, X_{th} and Y_{th} are the theoretical positions of the satellites and D_x , D_y are the correction to the theoretical positions in order to fit the model to the observed light curve. A possibility is to add another constant P depending on the receptor and to have:

$$E = K S + P.$$

K , D_x and D_y (and P) have to be determined during the process of inversion of the light curve.

b)building the model: the photometric function

Let's first build the photometric function of a mutual occultation

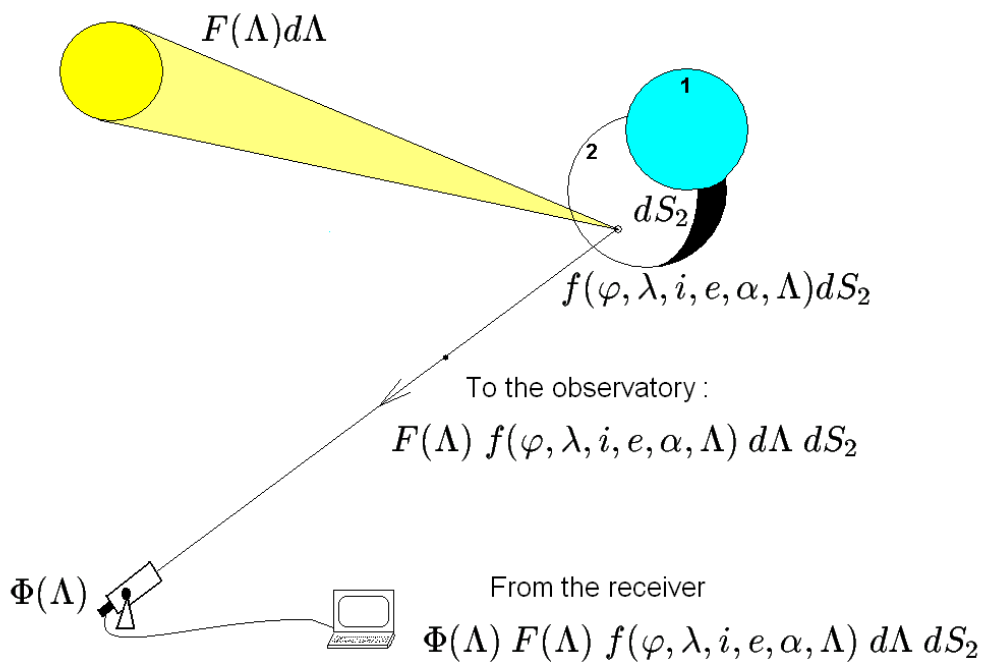

where :

α - phase angle

i - incidence angle

e - reflectance angle

φ, λ - cartographic coordinates

Λ - wavelength

As we saw it previously, the flux $S(X,Y)$ is supposed to arrived on Earth and $E(t)$ is the observed flux.

Let's build the function S :

Mutual occultation

$$S = \frac{G_b^{(a)} + G_b^{(p)}}{G_b^{(a)} + G_b^{(p)}} = \frac{1 + \frac{G_b^{(p)}}{G_b^{(a)}}}{1 + \frac{G_b^{(p)}}{G_b^{(a)}}}$$

$G_b^{(p)}$ outside of the event

$$G^{(p)} = \int_{S_2} \int_{\Lambda_1}^{\Lambda_2} \Phi(\Lambda) F(\Lambda) f_2(\varphi, \lambda, i, e, \alpha, \Lambda) d\Lambda dS_2$$

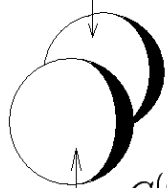

$$G^{(a)} = \int_{S_1} \int_{\Lambda_1}^{\Lambda_2} \Phi(\Lambda) F(\Lambda) f_1(\varphi, \lambda, i, e, \alpha, \Lambda) d\Lambda dS_1$$

You will note that it is very important to know the flux emitted each satellite outside the event, i.e. alone. This should be easily calculated through the theoretical values of albedoes and photometric characteristics of the satellites but these parameters are not well known as we will see later. So, the observation of these fluxes are highly recommended.

Let's now come to a **mutual eclipse**:

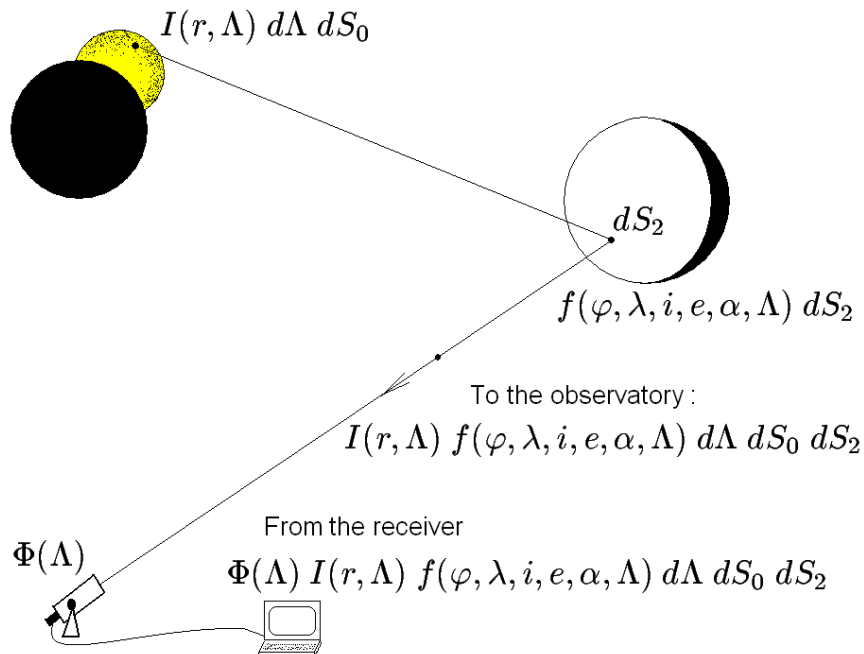

where :

α - phase angle

i - incidence angle

e - reflectance angle

φ, λ - cartographic coordinates

Λ - wavelength

The function S is build as follows :

Mutual eclipse

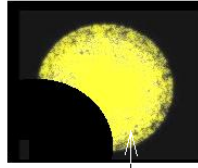
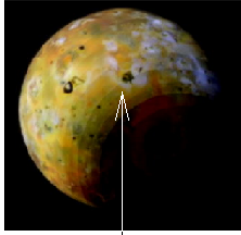

$$G^{(p)} = \int_{S_2} \int_{\Lambda_1}^{\Lambda_2} \Phi(\Lambda) f(\varphi, \lambda, i, e, \alpha, \Lambda) \int_{S_0} I(r, \Lambda) dS_0 d\Lambda dS_2$$

$$\boxed{G_b^{(p)} \text{ outside of the event}} \Rightarrow S = \frac{G^{(p)}}{G_b^{(p)}}$$

Note that we need here to know only flux of the eclipsed satellite outside the event, except if another satellite must be observed together with the eclipsed satellite. The, we need to observe this satellite alone before or after the event, when the satellites will be sufficiently far from each other.

The photometric function may be explained as follows in order to be more precise on what we wish to take into account:

$$f(\varphi, \lambda, i, e, \alpha, \Lambda) = R(\alpha, i, e, \Lambda) \cdot A(\varphi, \lambda, \Lambda)$$

R is the pure photometric function deduced from the reflection-scattering laws and A is depending on the location on the satellites, i.e. on a map of albedo of the surface of the satellite. However, such maps are not always available and then we will have:

$$f(\varphi, \lambda, i, e, \alpha, \Lambda) = R(\alpha, i, e, \Lambda) A(\theta, \Lambda)$$

Where A will just depend on the longitude of central meridian.

The figure below shows how A is determined from the albedo.

A is equal to 1 if there is no change of albedo on the satellite.

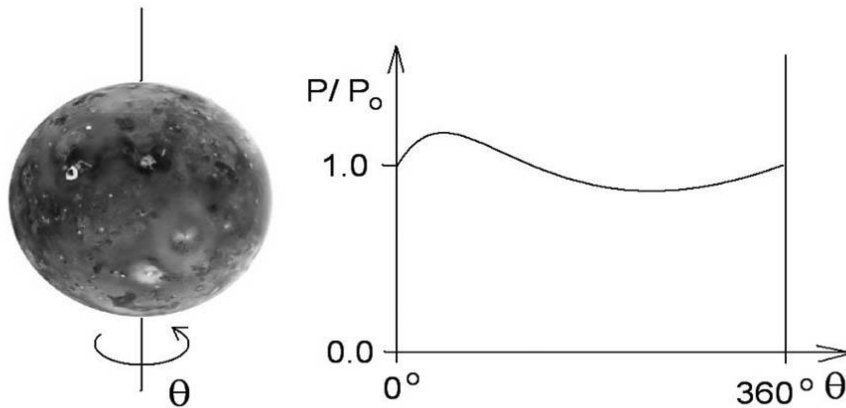

P is the integrated albedo on the visible side.

c) building the equations and solving the system

Now, we have all the elements to build the conditional equations linking all the parameters, known or unknown, for each observed photometric point of the light curve. The astrometric information which will be present as an unknown in each equation, will be the relative position of the two satellites at the time of the closest apparent approach (or the parameters described in the paragraph a) of “The complete photometric model”). Of course, we will keep some parameters as unknown if necessary such as the albedo of a satellite in a specific wavelength for which we have no information. Contrarily, if the albedo is well known in the observed wavelength, we will consider this albedo as known, decreasing the number of unknowns in the equations.

d) consequences on the observation

The building of the conditional equation shows us that the observers should be very attentive to the information needed for the reduction. There is, most of time, some lack of information on the albedo and light flux emitted by the satellites, especially when observing in specific wavelength. So that, it is important that the observers made photometric measurements of each involved satellite before and after the event. This makes necessary for the observers to arrive early before the event in order to be sure that the satellites are sufficiently far from each other in order to allow separate photometric measurements. The following figure shows what to be measured and why.

P is an unknown flux of light polluting the observation, R an unknown factor (P et R are systematic errors) and p_1, p_2 the albedoes of the satellites 1 and 2, r_1, r_2 the radii of the satellites 1 and 2..

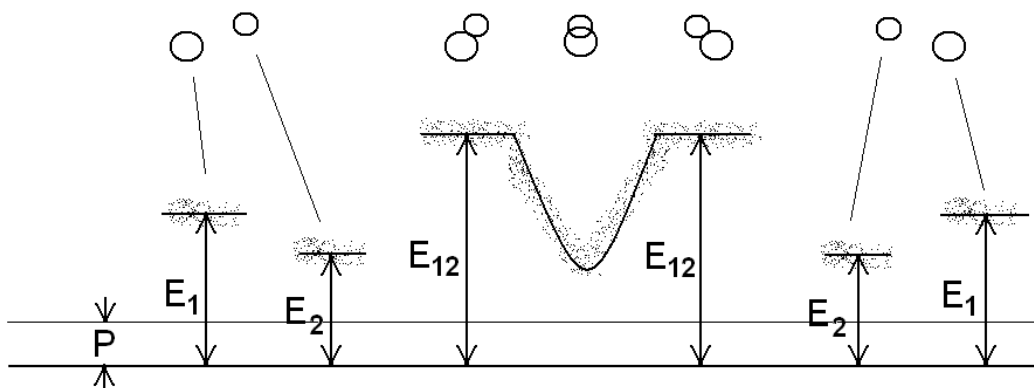

$$E_1 = Rp_1r_1^2 + P, \quad E_2 = Rp_2r_2^2 + P, \quad E_{12} = R(p_1r_1^2 + p_2r_2^2) + P$$

$$P = E_1 + E_2 - E_{12} \quad \frac{p_2}{p_1} = \frac{r_1^2}{r_2^2} \frac{E_{12} - E_1}{E_{12} - E_2}.$$

Knowing the filter used and the sensitivity of the receptor is also very important.

The past observations of mutual events

We saw above a set of light curves of observed mutual events: how many observations were made and what scientific results have been deduced from these observations?

The observations started in 1973 when the computers were able to calculate the predictions of the events sufficiently accurate to be sure to observe at the right time. Observing after the event or observing an event which is in fact only a close approach between the satellites will discourage the observers. These events are very sensitive to the relative inclinations of the orbits and a small error may make an event real or not. The table below makes an assessment of the observations made in the past.

	Number of light curves	Number of sites	Number of observed events	Number of observable events
Jupiter				
1973	91	26	65	176
1979	18	7	9	60
1985	166	28	64	248
1991	374	56	111	221
1997	275	42	148	390
2003	361	42	116	360
2009	520	52	240	237
Saturn				
1980	14	6	13	213
1995	66	16	43	182
2009	28	13	14	131
Uranus				
2007	36	16	27	193

Note: more observations could be available for the 2009 campaign

As we saw at the beginning of the present chapter, the purpose to determine an acceleration in the motion of the satellites may be deduced from astrometric observations. This work has been done for the Galilean satellites of Jupiter. The figure below shows the residuals in arcsec of all the observations used. We may see that the mutual events observations are more accurate than the HST observations.

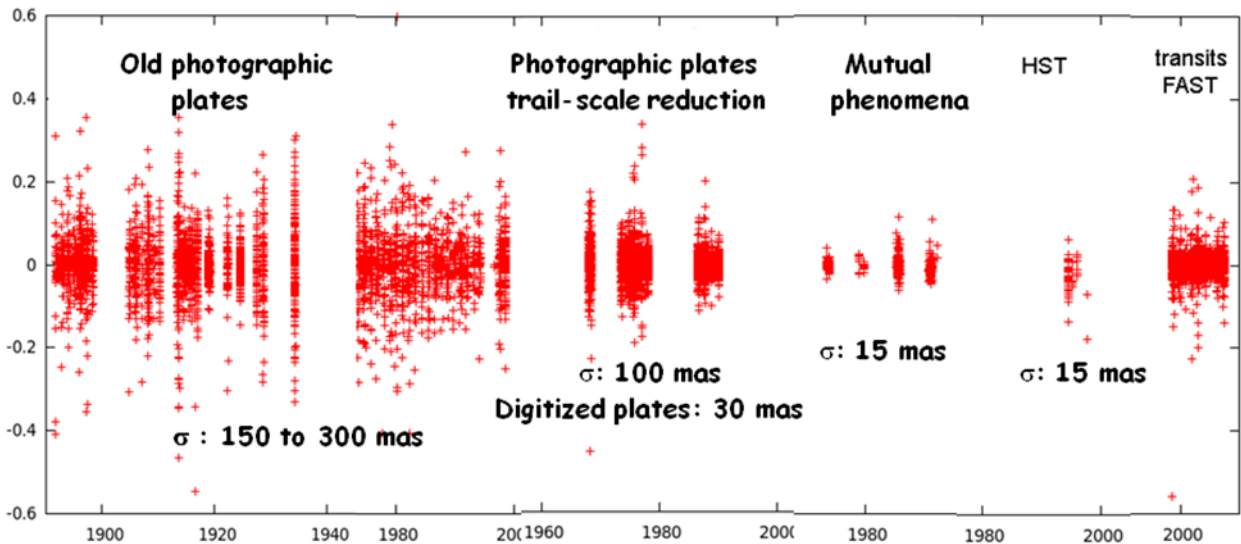

The 2015 campaign of observations of the events of the Galilean satellites

In 2015, mutual events will occur between the satellites of Jupiter. The magnitude of the satellites of Jupiter (around 5) allows observations even with a very small telescope. Note that the stability of the instrument is much more important than anything else. The images have to be stable on the receptor in order to facilitate the reduction procedure. When the observations will be made? The table below provides the dates of the opposition of the planets Jupiter together with the dates of the equinox and the declination of the planet. Some periods will be more favourable to the observations of the mutual events but the maximum of events must be observed and the events must be observed even in difficult conditions (twilight, fog,...) that has been shown to be possible.

	Jupiter
opposition	Feb. 6, 2015
conjunction	July. 26, 2014; Sept.7, 2015
equinox	January 31, 2015
declination	+23°/+15°
period of events	Aug. 2014.-Aug 2015

It may be deduced from this table that the mutual events of Jupiter will be better observed in Northern hemisphere from Oct. 2014 to June 2015.

References

A complete bibliography of publications on the mutual events is available at:

http://www.imcce.fr/en/observateur/campagnes_obs/phemu09/notes_tech/note08-en.php

Laws of diffusion and reflection of the light are studied in:

Theory of Reflectance and Emittance Spectroscopy by Bruce Hapke, 1993, Cambridge University Press